



NATIONAL
AUTOMATIC
MERCHANDISING
ASSOCIATION

Serving the Vending / Foodservice management industry

Multi-Drop Bus / Internal Communication Protocol

MDB / ICP

Supported by the Technical Members of:

NAMA	National Automatic Merchandising Association
EVA	European Vending Association
EVMMA	European Vending Machine Manufacturers Association

Version 4.2

February, 2011

National Automatic Merchandising Association

20 N. Wacker Drive, Suite 3500
Chicago, Illinois 60606-3120 USA
312-346-0370 FAX 312-704-4140

www.vending.org

(this page intentionally left blank)

Multi-Drop Bus / Internal Communication Protocol

Table of Contents

Revisions

Introduction

Section 1

General Information

1. Introduction
2. Operational and Application Notes
3. Levels and Options

Section 2

Communication Format

1. Byte Format
2. Block Format
3. Peripheral Addresses
4. Software Operational Rules
5. Typical Session Examples
6. File Transport Layer

Section 3

Bus Timing

1. Timing Definitions
2. Timing Specifications
3. Timing Diagram

Section 4

Hardware Specification

1. Bus Power Supply Definition
2. Bus Transmitter/Receiver Specification
3. Connector Specification
4. Example Schematic

Section 5

Coin Acceptor/Changer

VMC/Peripheral Communication Specifications

1. Introductions
2. VMC Commands
3. VMC Command Format
4. Changer Non-Response Time
5. Changer Power Requirements
6. Coin Acceptor/Changer Examples

Section 6

Bill Validator

VMC/Peripheral Communication Specifications

1. Introductions
2. VMC Commands
3. VMC Command Format
4. Bill Validator Non-Response Time
5. Bill Validator Power Requirements
6. Bill Validator / Recycler Examples

Section 7

Cashless Device(s)

VMC/Peripheral Communication Specifications

1. Introduction
2. State Definitions
3. Command Protocol
4. Cashless Device Command Response Formats
5. Cashless Device Non-Response Time
6. Cashless Device Power Requirements
7. Example Vend Sessions

Section 8

Communications Gateway

VMC/Peripheral Communication Specifications

1. Introduction
2. VMC Commands
3. Communications Gateway Command Format
4. Communications Gateway Non-Response Time
5. Communications Gateway Power Requirements
6. Communications Gateway Examples

Section 9

Universal Satellite Device

VMC/Peripheral Communication Specifications

1. Introduction
2. USD Summary
3. Command Protocol
4. USD Power Requirements
5. Examples - Mode 1 / 2 / 3 Sessions
6. Examples - Data Block Transfers
7. Examples - Communications

Section 10
Coin Hopper or Tube – Dispenser
VMC/Peripheral Communication Specifications

1. Introduction
2. VMC Commands
3. VMC Command Format
4. Dispenser Non-Response Time
5. Dispenser Power Requirements

Appendix 1
Currency Codes

Appendix 2
Battery Operated Card Reader

Appendix 3
MDB Recommended “Best Practices”

Revisions

Version 4.2

Version 4.1 of this specification is the sixth release of the international **Multi-Drop Bus / Internal Communication Protocol (MDB / ICP)**. This specification is the continued effort put forth by technical members of NAMA and the EVA. The basis for this specification is the Version 4.1 international **Multi-Drop Bus / Internal Communication Protocol (MDB / ICP)** released in July, 2010.

There is just one major change within cashless device(s) section, related to cashless devices commonly new in public (credit card) transactions. These devices, especially contactless operated, need an uninterrupted transaction starting with the actual correct vend price and therefore are not able to deliver a begin session in front of the transaction. Previous work arounds have been

- Always starting a begin session by cashless with “unknown credit”, which of course interferes with cash payment (normally a VMC would disable coin/bill acceptance, while a session is active)
- Forcing the customer to hold the payment media twice to the cashless device, once to start the session and second after pressing the selection to do the transaction.

The new modification allows such cashless devices, to identify themselves with an option bit, telling the VMC, that they are capable of accepting vend request, negative vend request and, if possible, revalue request, while in the enabled state as well as in the idle state.

If this option bit is set, a VMC will produce a vend request to the cashless whenever a selection is pressed and not sufficient cash credit is available. The cashless will proceed with this request like in the idle state. If in between, the customer will not present a valid cashless payment media and instead insert cash, the VMC will cancel the vend request with a vend cancel command and after this is accepted, a session complete to return to the enabled state.

Section 1 – General Information

Section 1.3.3

- Added b5, “always idle session” option

Section 7 – Cashless Device(s)

Section 7.2.3

- Added the “always idle session” option

Section 7.3

- Added the “always idle session” option

Section 7.4.4

- Added b5, “always idle session” option in Ident response

Section 7.7

- Added example #11, vend session (always idle session option set)
- Added example #12, vend session cancelled (always idle session option set)
- Added example #13, vend session timeout (always idle session option set)

Version 4.1

Version 4.1 of this specification is the fifth release of the international **Multi-Drop Bus / Internal Communication Protocol (MDB / ICP)**. This specification is the continued effort put forth by technical members of NAMA and the EVA. The basis for this specification is the Version 4.0 international **Multi-Drop Bus / Internal Communication Protocol (MDB / ICP)** released in April, 2009.

Of special note are the two major changes that were made to the specification:

- Changed the address of the second Coin Hopper / Tube Dispenser device peripheral in Section 10 from **68H** to **70H**.
- Added the Age Verification Device peripheral (address **68H**) in Section 11.

The following lists the primary revisions to the Version 4.1 of the **MDB / ICP**.

Section 2 – Communication Format

Section 2.3

- Changed the address for the second Coin Hopper or Tube – Dispenser to 01110xxxB (70H).
- Added address 01101xxxB (68H) for the Age Verification Device.

Section 5 – Coin Changer

- Corrected Page 5.14:
Expansion command send diagnostic status (0F 05) response data:
16 bytes: Z1-Z16 changed to 2 bytes: Z1-Z2

Section 6 – Bill Validator / Recycler

- Corrected Page 6.6:
Notes: 1. Dispenser setup (3703) command replaced by recycler enabled (3704).
- Corrected Page 6.13:
Under VMC Data: 19 bytes: Y1- Y19 replaced by Y1- Y18.
Y3-Y19 replaced by Y3 – Y18 = 16 bytes
- Corrected Page 6.14:
Y19 replaced by Y18
- Page 6.21, added after Expansion/ID:
FEATURE ENABLE →
← ACK

Section 10 – Coin Hopper or Tube - Dispenser

Section 10.1, 10.2, 10.3

- Changed second device address to 01110xxxB (70H).

Section 11 – Age Verification Device

- Added entire section.

Version 4.0

Version 4.0 of this specification is the fourth release of the international **Multi-Drop Bus / Internal Communication Protocol (MDB / ICP)**. This specification is the continued effort put forth by technical members of NAMA and the EVA. The basis for this specification is the Version 3.0 international **Multi-Drop Bus / Internal Communication Protocol (MDB / ICP)** released on March 26, 2003.

Of special note are the three major changes that were made to the specification:

- Added the Bill Recycler command set to the Bill Validator / Recycler device peripheral in Section 6.
- Added a second address to the Coin Hopper / Tube Dispenser device peripheral in Section 10.
- Added the MDB Recommended “Best Practices” as **Appendix 3**.

The following lists the primary revisions to the Version 4.0 of the **MDB / ICP**.

Section 2 – Communication Format

Section 2.3

- Added address 01101xxxB (68H) for the second Coin Hopper or Tube – Dispenser.

Section 5 – Coin Acceptor / Changer

Section 5.3

- Added information regarding “Just Reset”.
- Corrected typo for POLL command to **08h**.
- Added “Type activity” definitions in POLL Status section.
- Added Section 5.6 **Coin Acceptor/Changer Examples**.

Section 6 – Bill Validator

Section 6.3

- Added information regarding “Just Reset”.
- Added “Type activity” definitions in POLL Status section
- Added all new command/responses for the Bill Recycler.

37H - 03H	RECYCLER SETUP
37H - 04H	RECYCLER ENABLE
37H - 05H	BILL DISPENSE STATUS
37H - 06H	DISPENSE BILL
37H - 07H	DISPENSE VALUE
37H - 08H	PAYOUT STATUS
37H - 09H	PAYOUT VALUE POLL
37H - 0AH	PAYOUT CANCEL

- Added Section 5.6 **Bill Validator/Recycler Examples.**

Section 7 – Cashless

Section 7.3

- Added information regarding “allows selection without displaying balance” in the Begin Sessions (03H) – Funds Available response.

Section 7.5

- Added information regarding using the Non-Response time for commands that require data to be returned.

Section 7.7

- Added Controller “ACKs” to the end of the card reader session examples.

Section 8 – Communication Gateway

Section 8.2

- Added 1FH/02H TIME/DATE REQUEST to VMC Command table.

Section 8.3

- Added option bit b2 :Expansion Time/Date Request command
- Added 1FH/02H TIME/DATE REQUEST command/response.

Section 9 – Universal Satellite Device (USD)

Section 9.3

- Corrected errors in 07H - Z3 to Z33 designations.

Section 10 – Coin Hopper or Tube - Dispenser

Section 10.1, 10.2, 10.3

- Added a second devices as address 11001xxxB (68H).
- Expanded on the "Coins Dispensed" section of the DISPENSER STATUS response.

Appendix 3 – MDB Recommended “Best Practices”

- Added entire appendix.

Version 3.0

Version 3.0 of this specification is the third release of the international **Multi-Drop Bus / Internal Communication Protocol (MDB / ICP)**. This specification is the continued effort put forth by technical members of NAMA and the EVA. The basis for this specification is the Version 2.0 international **Multi-Drop Bus / Internal Communication Protocol (MDB / ICP)** released on October 4, 2002.

Of special note are the four major changes that were made to the specification:

- Added a second Cashless Device peripheral address in Section 7
- Replaced the Audit Unit with the Communications Gateway in Section 8
- Added the Coin Hopper or Tube – Dispenser in Section 10 (new)
- Assigned 2 addresses to be used for experimental peripherals

The following lists the primary revisions to the Version 3.0 of the **MDB / ICP**.

Section 1 – General Information

Section 1.3

- Changed the Level and Options chart for the Communications Gateway and the Coin Hopper or Tube – Dispenser

Section 2 – Communication Format

Section 2.2

- Added headers for the Response Codes
- Clarified non response processing for Master-to-Peripheral and Peripheral-to-Master communication.

Section 2.3

- Updated the Peripheral Address table for the Communications Gateway, Coin Hopper, Cashless Payment 1, and Experimental addresses
- Defined the use of the experimental addresses

Section 2.5

- Added new RESET examples F & G.

Section 5 – Coin Acceptor / Changer

Section 5.2

- Renamed the STATUS command to SETUP command
- Added a new Possible Credited Coin Removal status code (0Dh)

Section 6 – Bill Validator

Section 6.2

- Renamed the STATUS command to SETUP command
- Added a new Possible Credited Bill Removal status code (0Ch)

Section 7 – Cashless Device(s)

(New Cashless Device #2)

Changed name from Cashless Payment to Cashless Device

Section 7.1

- Added information regarding the dual addresses for two Cashless Device peripherals (10h and 60h)

Section 7.3

- Updated Command & Response table for dual addresses

Section 7.4

- Updated Command/Response Formats for dual addresses

Section 8 – Communications Gateway

(New Peripheral)

Sections 8.1 through 8.6

- Replaced former Audit Unit sections with new Communications Gateway Sections

Section 9 – Universal Satellite Device (USDC)

Section 9.3

- Updated POLL table with proper number of bytes (FTL portion)
- Changed “numeric row and column” to “Item Number”

Section 10 – Coin Hopper or Tube – Dispenser

(New Peripheral)

Sections 10.1 through 10.5

- Added complete new sections

Version 2.0

Version 2.0 of this specification is the second release of the international **Multi-Drop Bus / Internal Communication Protocol (MDB / ICP)**. This specification is the culmination of effort put forth by technical members of NAMA, the EVMMA, and the EVA. The basis for this specification is the Version 1.0 international **Multi-Drop Bus / Internal Communication Protocol (MDB / ICP)** released on October 14, 1998.

The following lists the primary revisions to the Version 2.0 of the **MDB / ICP**

Introduction

Foreword

- Clarified that the Standard is a communication interface

Section 1 - General Information

Section 1.1

- Added 3rd paragraph noting interface specification vs. system specification

Section 1.3

- Added entire Levels and Options section

Section 2 - Communication Format

Section 2.1

- Changed Mode Bit Master-to-Peripheral text

Section 2.2

- Removed “command” from Master-to-Peripheral 4th paragraph
- Changed RET description

Section 2.3

- Defined address 0000xxxB (00H) for VMC
- Provided address information to show hexadecimal format

Section 2.4

- Changed format to 2.4.X sub-sections and added 2.4.4 on Levels

Section 2.5

- Changed RET description

Section 2.6

- Added complete File Transport Layer Section

Section 3 - Bus Timing

Section 3.1

- Added 2nd sentence to t_{setup}

Section 4 - Hardware Specification

Section 4.3

- Modified complete section and added AMP as alternate source to Molex

Section 4.4

- Added pin numbers to schematic

Section 5 - Coin Acceptor / Changer

Section 5.1

- Provided additional address information

Section 5.3

- Added recommended RESET command sequence
- Modified STATUS response to indicate Country / Currency Codes
- Modified County / Currency Code to include ISO 4217 (Appendix A1)
- Added Note 2 to DISPENSE (ODH) command
- Added FTL POLLED responses
- Added FTL “b3” option bit
- Added FTL expansion commands
- Cosmetic changes to all EXPANSION commands
- Split ALTERNATIVE PAYOUT (0FH-02H) and PAYOUT STATUS (0FH-03H) command into two separate commands (cosmetic change only)
- Added text to ALTERNATIVE PAYOUT (0FH-02H) Y1 description
- Added Note 3 to ALTERNATIVE PAYOUT STATUS (0FH-03H)

Section 5.5

- Added “**See Note 2 ...**” text
- Added “If both peripherals supported” to Note

Section 6 - Bill Validator

Section 6.1

- Provided additional address information

Section 6.3

- Added recommended RESET command sequence
- Modified STATUS response to indicate Country / Currency Codes
- Modified County / Currency Code to include ISO 4217 (Appendix A1)
- Added Level 2 information
- Added Level 2 option bytes w/ new EXPANSION COMMANDS:
 - 37H 01H Level 2 Option Bit Enable
 - 37H 02H Level 2 Identification
- Added FTL POLLED responses
- Added FTL “b0” option bit
- Added FTL expansion commands
- Modified last sentence in SECURITY command to link to Z9-Z10 STATUS response
- Cosmetic changes to all EXPANSION commands

Section 6.5

- Added “If both peripherals supported” to Note

Section 7 - Cashless Payment

Section 7.2 & 7.2.7

- Added Level 03 Negative Vend Request

Section 7.2.2

- Changed 1st sentence to link Setup to 7.4.1 information

Section 7.2.4

- Added Negative Vend and Revalue

Section 7.2.7

- Added Level 03 Negative Vend Request

Section 7.3

- Added bold text regarding defining currency at the beginning of a session
- Broke uninterruptable table into VMC Command and Reader Response
- Added Level 03 NEGATIVE VEND REQUEST to VMC Command table
- Added Level 03 DATA ENTRY REQUEST to Reader Response table
- Highlighted command out of sequence hard resets from VMC
- Moved Vend Failure Sequence to 7.4.8

Section 7.3 – Table 1

- Changed name to COMMANDS & RESPONSES
- Changed Comment column to VMC / Reader Level Support
- Linked all commands and responses to Levels
- Added DATA ENTRY REQUEST POLLED responses
- Added FTL POLLED responses
- Added FTL commands
- Added NEGATIVE VEND REQUEST responses
- Defined 14H-1AH and 20H-FEH as “For Future Use”

Section 7.4.1

- Cosmetically modified RESET command sequence
- Added 32 bit SETUP MAX/MIN PRICE
- Changed text following **Reader response**

Section 7.4.2

- Clarified Level 01 information (reader has no revalue capability)
- Added Level 03 information
- Modified SETUP response to indicate Country / Currency Codes
- Modified County / Currency Code to include ISO 4217 (Appendix A1)
- Added bold Note in Z3-Z4 County / Currency Code
- Added definition for Miscellaneous Options “b4 – b7”

Section 7.4.3

- Added Level 03 SETUP if Expanded Currency Mode

Section 7.4.4

- Added Level 03 BEGIN SESSION response if Expanded Currency Mode
- Added Level 03 VEND APPROVED response if Expanded Currency Mode

- Added Level 03 PERIPHERAL ID response if Expanded Currency Mode
- Clarified COMMAND OUT OF SEQUENCE definition
- Added Level 03 REVALUE LIMIT AMOUNT response if Expanded Currency Mode
- Added Level 03 DATA ENTRY REQUEST response if Data Entry Mode
- Added Level 03 DATA ENTRY CANCEL response if Data Entry Mode
- Added Level 03 FTL REQ TO RCV response if FTL Mode
- Added Level 03 FTL RETRY / DENY response if FTL Mode
- Added Level 03 FTL SEND BLOCK response if FTL Mode
- Added Level 03 FTL OK TO SEND response if FTL Mode
- Added Level 03 FTL REQ TO SEND response if FTL Mode

Section 7.4.5

- Added Level 03 VEND command if Expanded Currency Mode
- Added Level 03 VEND APPROVED response if Expanded Currency Mode

Section 7.4.8

- Added Vend Failure (from 7.3)

Section 7.4.10

- Added Level 03 VEND command if Expanded Currency Mode

Section 7.4.11 (new)

- Added complete Level 03 NEGATIVE VEND Request section

Section 7.4.15 (new)

- Added complete Level 03 DATA ENTRY Request section

Section 7.4.16

- Added Level 03 REVALUE Request command if Expanded Currency Mode

Section 7.4.17

- Added Level 03 REVALUE Limit Request command if Expanded Currency Mode

Section 7.4.18

- Added Level 03 EXPANSION REQUEST ID response if Expanded Currency Mode

Section 7.4.22

- Added Level 03 EXPANSION ENABLE OPTIONS command

Section 7.4.23

- Added Level 03 FTL REQ TO RCV command & responses if FTL Mode

Section 7.4.24

- Added Level 03 FTL RETRY / DENY command if FTL Mode

Section 7.4.25

- Added Level 03 FTL SEND BLOCK command & response if FTL Mode

Section 7.4.26

- Added Level 03 FTL OK TO SEND command if FTL Mode

Section 7.4.27

- Added Level 03 FTL REQ TO SEND command & responses if FTL Mode

Section 7.7

- Added Example Vend Session #10 (Single Negative Vend)

Section 8 - Audit Device

Section 8.1

- Provided additional address information

Section 8.3

- Added FTL POLLED responses
- Added FTL “b3” option bit
- Added FTL expansion commands

Section 9 - Universal Satellite Device

Section 9.1

- Provided additional address information

Section 9.3

- Added FTL POLLED responses
- Added FTL “b2” option bit
- Added FTL expansion commands

Document Revision History

- Deleted

Appendix 1 - Currency Codes

- Added entire section (based on **ISO 4217**)

Appendix 2 - Battery Operated Card Reader

- Added entire section

Version 1.0

Version 1.0 of this specification is the first release of the international **Multi-Drop Bus / Internal Communication Protocol (MDB / ICP)**. This specification is the culmination of effort put forth by technical members of NAMA, the EVMMA, and the EVA. The basis for this specification is the **International Multi-Drop Bus Interface Standard** published by NAMA and the **Internal Communication Protocol** published by the EVMMA. The NAMA document was originally introduced on October 19, 1993 and later revised on August 19, 1994, June 20, 1997, and October 15, 1997. The EVMMA document was adopted in 1994 and later revised in 1995.

The following lists the primary revisions to the original two documents which were “combined” to create Version 1.0 of the **MDB / ICP**. In actuality, the NAMA **MDB** was the basis of the **MDB / ICP** with the exception of Section 7 which came from the EVMMA **ICP**. Besides typographical corrections and actual feature changes (below), the entire document was edited to provide a more uniform appearance.

The following lists the primary revisions to the Version 1.0 of the **MDB / ICP**.

Hardware Specification - Section 4.3

- Added drawings of the MDB male and female connectors.

Coin Acceptor / Changer - Section 5.3

- Added Expansion commands:
 - 0F-05 Send Current Diagnostic Status
 - 0F-06 Send Controlled Manual Fill Report
 - 0F-07 Send Controlled Manual Payout Report

Coin Acceptor / Changer - Section 5.5

- Added coin acceptance and coin payout power requirements for coin changers using motorized payout mechanisms.
- Added note about simultaneously supplying bill validator transport power.

Bill Validator - Section 6.5

- Added note about simultaneously supplying coin mechanism coin acceptance power.

Cashless Payment - Section 7.2.6

- Added Level 02 Revalue capability.

Cashless Payment - Section 7.3

- Added Level 02 REVALUE REQUEST.
- Removed NAK (NCK) response from uninterruptable state and unexecutable command descriptions.
- Eliminated the BUSY response to vend failure sequences.
- Modified Table 1 per above.

Cashless Payment - Section 7.4.1

- Further defined the initializing sequence following a RESET command.

Cashless Payment - Section 7.4.2

- Further defined the Z7 Application Maximum Response Time.
- Added Z8 – b3 for supporting the VEND/CASH SALE subcommand.

Cashless Payment - Section 7.4.4

- Begin Session (03h) - Added Level 02 Reader Z4-Z10 data.
- Malfunction/Error (0Ah) - Added error code 1100 (refund error).
- Command Out of Sequence (0Bh) - Added Z2 data.
- Eliminated Busy (0Ch) response.
- Added Level 02 Reader Revalue Approved (0Dh) response.
- Added Level 02 Reader Revalue Denied (0Eh) response.
- Added Level 02 Reader Revalue Limit Amount (0Fh) response.

- Added Level 02 Reader User File Data (10h) response.
- Added Level 02 Reader Time/Date Request (11h) response.

Cashless Payment - Section 7.4.10

- Added Level 01 Reader CASH SALE (13h/05h) VMC command.

Cashless Payment - Section 7.4.14

- Added Level 02 Reader Revalue - Request (15h/00h) VMC command.

Cashless Payment - Section 7.4.15

- Added Level 02 Reader Revalue – Limit Request (15h/01h) VMC command.

Cashless Payment - Section 7.4.17

- Obsoleted EXPANSION – Read User File (17h/01h) VMC command.

Cashless Payment - Section 7.4.18

- Obsoleted EXPANSION – Write User File (17h/02h) VMC command.

Cashless Payment - Section 7.4.19

- Added Level 02 Reader Write Time/Date File (17h/03h) VMC command.

Cashless Payment - Section 7.5

- Further defined the non-response time with the “Application Maximum Response Time” Z7.

Cashless Payment - Section 7.6 (original ICP Spec)

- Moved this section (ICP Payment Media Return Button) to Section 7.3.2.

Cashless Payment - Section 7.6 (MDB/ICP Spec)

- Previously was the ICP 7.7 with no modifications.

(this page intentionally left blank)

Introduction

Foreword

This voluntary Standard contains basic requirements for a vending machine communication interface within the limitations given below and in the General Information section of this Standard. These requirements are based on sound engineering principles, research, field experience, and an appreciation of the problems of manufacture, installation, and use derived from consultation with and information obtained from manufacturers, users, and others having specialized experience. These requirements are subject to revision as further experience and investigation may show it necessary or desired.

NAMA, in performing its functions in accordance with its objectives, does not assume or undertake to discharge any responsibility of the manufacturer or any other party. The opinions and findings of NAMA represent its professional judgment given with due consideration to the necessary limitations of practical operation and state of the art at the time the NAMA Standard is processed. NAMA shall not be responsible to anyone for use or reliance upon Standard by anyone. NAMA shall not incur any obligation or liability for damages, including consequential damages, arising out of or in connection with the use, interpretation of, reliance upon this Standard.

Standard Review

A complete review of this standard shall be conducted at least every five years to keep requirements consistent with technology. These reviews shall be conducted by representatives from industry and user groups on the NAMA Vending Technology Standards Committee at that time.

(this page intentionally left blank)

Section 1

General Information

1.1 Introduction

This document defines a serial bus interface for electronically controlled vending machines. The interface is a 9600 baud Master-Slave arrangement where all peripherals are Slaves to a Master controller.

The intent of this document is to standardize vending machines that employ electronic control (traditionally known as vending mechanism controller - VMC) so that all vending and peripheral equipment communicates identically.

It should be noted that this document is a vending machine interface / protocol specification and **not** a vending machine system specification. Each machine manufacturer should provide a specification on the overall operation of the machine.

1.2 Operational and Application Notes

The serial bus, or Multi-Drop Bus (MDB) is configured for Master-Slave operation. There is one Master with capability of communicating with up to thirty-two peripherals. The Master is defined as the Vending Machine Controller (VMC).

Each peripheral is assigned a unique address and command set. The master will “poll” the Bus for peripheral activity. That is, each peripheral is asked for activity, and responds with either an acknowledge, negative acknowledgment, or specific data dependent on its current activity. If a peripheral does not respond within a predefined time, (t-non-response as defined in the peripheral sections) it is assumed that it is not present on the Bus.

Bus interference, or “crashes” are prevented because each peripheral only responds upon being polled. Since there is only one master, and all communication is initiated by the Master, Bus “crashes” are easily precluded.

All peripherals will recognize a disable command, or commands, sent by the Master. This allows for disabling of individual peripherals for various reasons, for example, power management techniques.

Error checking and correction is accomplished by using checksums (CHK) and a retransmit command.

1.3 Levels and Options

Since the introduction of the earliest Multi-Drop Bus specification, functional levels and operational options have been established for most of the peripherals on the MDB/ICP interface. These have provided the capability for new features to be implemented as new requirements and features were needed for the international vending industry.

1.3.1 Levels

Levels of peripheral functionality were established when a major change occurred in the peripheral that added extended commands and responses. Due to potential conflicts between a VMC level and a peripheral level, neither the VMC nor the peripheral should issue a command or reply with a response that is not supported by the other device.

The VMC must initially determine (via the appropriate STATUS or SETUP command) the level of a peripheral before determining which commands it can issue to that device. **A VMC must only send commands that are supported by the peripheral.** For example, a Level 3 command may only be issued to a Level 3 or higher peripheral and must not be issued to a Level 1 or 2 peripheral.

The Cashless Payment and the Universal Satellite Device can also learn the respective level of the VMC for that device. This information is sent via the SETUP command. **It is the responsibility of the peripheral to only send responses that are supported by the VMC.** For example, a Level 3 response may only be sent to a Level 3 or higher VMC and must not be sent to a Level 1 or 2 VMC. Effectively, the VMC and peripheral should support the highest common level.

For total compatibility, VMCs and peripherals should support all lower levels. **For new designs after July 2000, it is strongly recommended that VMCs and peripherals must support all lower levels.** Commercial or regional issues may cause machine or peripheral manufacturers to implement only specific levels; however, this is a decision (and risk) made by the machine or peripheral manufacturer.

1.3.2 Options

Options were established in the peripherals to provide various additional operational features that may be required for specific vending applications. As the name implies, these features are “above and beyond” the standard core of required functionality.

At power on and after a Bus Reset or a RESET command, all options are disabled. During the initialization command sequences, the VMC determines the optional features supported by the peripherals. The VMC will then enable the features it is going to use. Until the feature is enabled, it is the responsibility of the peripheral to ignore feature specific commands and not respond with feature specific responses.

1.3.3 Currently Established Levels and Options

The following table provides a brief description of each of the currently established levels and options of the various MDB/ICP peripherals. Please refer to the specific sections for each device for more detailed information.

Peripherals	Levels	Options	Description
Coin Changer	1	n/a	Never released
	2	none	Supports standard commands
	3	below	Supports Expansion ID command and <u>optionally</u> supports commands for features below
		b0	Alternative Payout Method
		b1	Extended Diagnostics
		b2	Controlled Manual Fill and Payout
	b3	File Transport Layer (FTL)	
Bill Validator	1	none	Supports standard commands and Expansion ID command <u>without</u> options
	2	below	Supports expansion ID command <u>with</u> options and <u>optionally</u> supports commands for features below
		b0	File Transport Layer (FTL)
		b1	Bill Recycling
Cashless Device #1 & #2	1	below	Supports standard commands and Expansion ID command. Readers do not have revaluation capability
		b0*	Reader is capable of restoring funds to card
		b1*	Reader is multivend capable
		b2*	Reader has a display available
		b3*	Reader supports VEND-CASH SALE command
		*bits in the SETUP-Config command	
	2	above	Supports Revalue, Time/Date, Read User File (obsolete), and Write User File (obsolete) commands

Peripherals	Levels	Options	Description
Cashless Device #1 & #2 (continued)	3	above & below	Supports expansion ID command <u>with</u> options and <u>optionally</u> supports commands for features below (bits in the Level 3 Expansion ID command)
		b0**	File Transport Layer (FTL)
		b1**	16 or 32 Bit Monetary Format
		b2**	Multi Currency / Multi Lingual
		b3**	Negative Vend
		b4**	Data Entry
		b5**	Always Idle Session
			**bits in the Level 3 Expansion ID command
Communications Gateway	1	none	Obsolete (former Audit Unit)
	2	none	Obsolete (former Audit Unit)
	3	below	Supports Expansion ID command and <u>optionally</u> supports commands for features below
		b0	File Transport Layer (FTL)
		b1	Verbose Mode
		b2	Expansion Time/Date
Universal Satellite Device (USD)	1	below	Supports all basic commands and <u>optionally</u> supports commands for features below
		b0	USD is capable of storing and controlling pricing
		b1	USD is capable of selecting items to vend
		b2	File Transport Layer (FTL)
Coin Hopper or Tube - Dispenser	1	below	Supports Expansion ID command and <u>optionally</u> supports commands for features below
		b0	File Transport Layer (FTL)

2.2 Block Format

Master-to-Peripheral

A Communication Block for Master-to-Slave transmissions is defined as an Address byte, optional data bytes, and a CHK byte. A block is limited to a maximum of thirty-six (36) bytes.

The upper five bits (MSB) of the Address Byte will be used for addressing. That is, bits 7,6,5,4,3 of the previous byte description will be used for addressing.

The lower three bits (i.e. 2,1,0) of the Address Byte will contain peripheral specific commands. This will allow up to eight instructions to be embedded in the first byte of a block.

The VMC Master will respond to data from a peripheral with an Acknowledgment (ACK), Negative Acknowledgment (NAK), or Retransmit (RET). These are defined later in the document. The 5 mS time-out (t-response) described in the Bus Timing section of this document is the equivalent of a NAK.

If the addressed Slave does not respond within the 5 mS time-out (silence), the Master may repeat the same command, or send a different command, until it receives an answer or until the end of the Non-Response time, as defined in the peripheral sections. See Example in 2.5D. The RESET command should not be used as a recovery method to a 5 mS time-out (t-response) until after exceeding the Non-response time. The VMC may send commands to any other peripheral during this time.

Peripheral-to-Master

A Communication Block for Slave-to-Master transmissions consists of either a data block and a CHK byte, a acknowledgment (ACK), or a negative acknowledgment (NAK).

The 5 mS time-out (t-response) described in the Bus Timing section of this document is the equivalent of a NAK command. In addition, it is recommended that the peripheral use this time-out as the NAK when a reception error of the ADDRESS byte occurs. This will prevent several peripherals from trying to simultaneously respond with a NAK.

A data block consists of one or more data bytes followed by a CHK byte. The CHK byte is defined later in this document.

The data block and CHK byte are limited to a maximum size of 36 bytes.

A CHK byte is not required when a peripheral responds with NAK or ACK byte. ACK and NAK are defined later in this document.

The peripheral must set the mode bit on the last byte sent to signify end of transmission. This will be either the CHK byte of a block, a NAK byte, or an ACK byte. The mode bit must not be set except for the conditions above.

A peripheral response of ACK or NAK signifies the end of the exchange.

When a peripheral responds with a data block, the VMC must respond with an ACK, NAK or RET. If the Master cannot respond within the 5 mS time-out (t-response) the peripheral must repeat the data block, or append it, at the next possible occasion (i.e. to a later POLL). The same behavior is to apply when the Master responds with NAK.

CHK Byte

A CHK byte must be sent at the end of each block of data. The CHK byte is a checksum calculated by adding the ADDRESS byte and all DATA bytes. The CHK byte is not included in the summation. The carry bit for CHK additions is ignored since the CHK byte is limited to eight bits.

The following example shows a CHK byte calculation for a possible response to a STATUS command sent to a USA changer slave. See section 5 for details of byte meanings.

02H	Changer feature level
00H	Country code for USA
01H	Country code for USA
05H	Coin scaling factor
02H	Decimal place
00H	Coin type routing
07H	Coin type routing
01H	Coin type 0 has value of 1 scaling factor
02H	Coin type 1 has value of 2 scaling factor
05H	Coin type 2 has value of 5 scaling factor
14H	Coin type 3 has value of 20 scaling factor
<u>FFH</u>	<u>Coin type 4 is a token</u>
12CH	Therefore the CHK byte would be equal to 2CH

A checksum will be performed on all full blocks of communication. A checksum will not be performed on ACK, NAK, or RET bytes.

Response Codes

The following codes are reserved for the ACK, NAK and RET bytes:

ACK	00H	(acknowledgment/checksum correct)
RET	AAH	(Retransmit the previously sent data. Only the VMC can transmit this byte)
NAK	FFH	(Negative acknowledge)

The VMC and peripheral must also recognize the 5 mS time-out (t-response) as a NAK.

NOTE: To improve system reliability it is recommended that when receiving ACK, NAK, or RET the receiving device counts the number of bits set in the byte. This method will require at least two bit errors in the byte before the byte can be mis-interpreted.

Bus Reset

The VMC may reset all peripherals by pulling the transmit line “active” for a minimum of 100 mS. This informs all peripherals to abort any activity and return to its power-on reset state. Details of this state for each peripheral are provided in later sections of this document. It is recommended that the VMC re-initialize each peripheral after this type of reset.

2.3 Peripheral Addresses

The addresses below are defined. Note again that the bits shown are the upper five bits (7,6,5,4,3) of the Address Byte and will be used for all addressing including the File Transport Layer described in Section 2.6. The lower three bits (2,1,0) are used for the command.

<u>Address</u>	<u>Definition</u>
00000xxxB (00H)	Reserved for VMC
00001xxxB (08H)	Changer
00010xxxB (10H)	Cashless Device #1
00011xxxB (18H)	Communications Gateway
00100xxxB (20H)	Display
00101xxxB (28H)	Energy Management System
00110xxxB (30H)	Bill Validator
00111xxxB (38H)	Reserved for Future Standard Peripheral
01000xxxB (40H)	Universal Satellite Device #1
01001xxxB (48H)	Universal Satellite Device #2
01010xxxB (50H)	Universal Satellite Device #3
01011xxxB (58H)	Coin Hopper or Tube – Dispenser 1
01100xxxB (60H)	Cashless Device #2
01101xxxB (68H)	Age Verification Device
01101xxxB (70H)	Coin Hopper or Tube – Dispenser 2
01111xxxB (78H)	Reserved for Future Standard Peripherals
.	.
.	.
.	.
11011xxxB (D8H)	Reserved for Future Standard Peripherals
11100xxxB (E0H)	Experimental Peripheral #1
11101xxxB (E8H)	Experimental Peripheral #2
11110xxxB (F0H)	Vending Machine Specific Peripheral #1
11111xxxB (F8H)	Vending Machine Specific Peripheral #2

Experimental Peripheral Addresses

Experimental Peripheral addresses 11100xxxB (E0H) and 11101xxxB (E8H) are reserved for use by manufacturers when designing and field testing potential new MDB/ICP devices. These addresses are **temporary** and once the new device is approved by NAMA and the EVA, the device will be assigned a different permanent peripheral address. Use of the Experimental Peripheral addresses shall be limited to “in house” testing and “closed site” field trials. Manufacturers must understand that any devices in the field with Experimental Peripheral addresses must be recalled or updated to the permanent address if the device is approved by NAMA and the EVA. If not approved by NAMA and the EVA, the devices must be recalled or have their addresses changed to the Vending Machine Specific peripheral addresses described below.

Vending Machine Specific Peripheral Addresses

Vending Machine Specific peripheral addresses (addresses 11110xxxB (F0H) and 11111xxxB (F8H)) are reserved for Non-Standard or proprietary applications. These devices are allowed a unique set of commands.

All other peripherals are defined as Standard devices. These peripherals must follow the specifications to ensure compatibility between manufacturers.

2.4 Software Operational Rules

2.4.1 Power Budget

The VMC must regulate the power budget. That is, peripherals must be enabled and disabled dependent on power availability. The power bus is defined later in this document.

2.4.2 Bytes

During multi-byte messages the most significant byte is sent first.

Any bytes within a command or response that are not specifically defined should be left in a 0 state. For Level 03 or lower coin mechanisms, Level 01 bill validators, and Level 01 card readers, this is not a requirement but a suggestion.

2.4.3 Polling

The following are recommendations for the methods of VMC to peripheral software operation.

Each peripheral should be polled every 25-200 milliseconds. This can be done by the POLL command or any other appropriate command.

If a peripheral has not responded to a poll for its maximum Non-Response time, the VMC should continue to poll the peripheral at least every ten seconds with a RESET command. (See Example G in Section 2.5).

2.4.4 Levels

Due to potential conflicts between a VMC level and a peripheral level, neither the VMC nor the peripheral should issue a command or reply with a response that is not supported by the other device.

The VMC must initially determine (via the appropriate STATUS or SETUP command) the level of a peripheral before determining which commands it can issue to that device. **A VMC must only send commands that are supported by the peripheral.** For example, a Level 3 command may only be issued to a Level 3 or higher peripheral and must not be issued to a Level 1 or 2 peripheral.

The Cashless Payment and the Universal Satellite Device can also learn the respective level of the VMC for that device. This information is sent via the SETUP command. **It is the responsibility of the peripheral to only send responses that are supported**

by the VMC. For example, a Level 3 response may only be sent to a Level 3 or higher VMC and must not be sent to a Level 1 or 2 VMC. Effectively, the VMC and peripheral should support the highest common level.

For total compatibility, VMCs and peripherals should support all lower levels. **For new designs after July 2000, it is strongly recommended that VMCs and peripherals must support all lower levels.** Commercial or regional issues may cause machine or peripheral manufacturers to implement only specific levels; however, this is a decision (and risk) made by the machine or peripheral manufacturer.

2.5 Typical Session Examples

A. The diagram below represents a typical transmission when a peripheral is idle.

VMC:

_____ ADD* _____ CHK _____

Peripheral:

_____ ACK* _____

B. The diagram below represents a typical transmission when a peripheral has data to return.

VMC:

_____ ADD* _____ CHK _____ ACK _____

Peripheral:

_____ DAT _____ DAT _____ CHK* _____

C. The diagram below represents a typical transmission when the VMC has data to send.

VMC:

_____ ADD* _____ DAT _____ DAT _____ CHK _____

Peripheral:

_____ ACK* _____

*Indicates mode bit set

- D. The diagram below represents a typical transmission when the VMC determines a CHK is not correct. The VMC will respond one of two ways:

Send a NAK to the peripheral to indicate that the information was not received correctly then perform other tasks. Note: When the Master answers with NAK (or silence which is treated equally) the slave has to repeat the response, in order to ensure the execution of the response (i.e. coin reception etc.).

OR

The VMC may send a retransmit (RET) command alerting the peripheral to retransmit the previously sent data.

VMC:

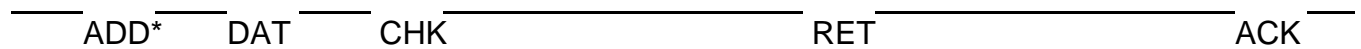

Peripheral:

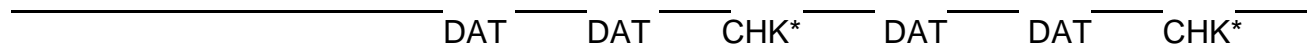

*Indicates mode bit set.

- E. This diagram represents a situation where the peripheral does not respond within the 5 mS time-out (t-response).

VMC:

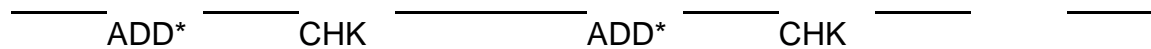

Peripheral:

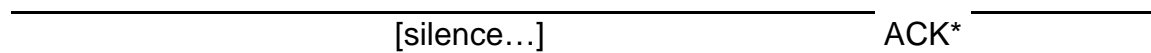

F. This diagram represents a situation where the peripheral does not respond to a command and after its maximum Non-Response time, is reset by the controller.

Controller	Peripheral	Comment
Command X	→ ← Response	Normal response
Command Y	→ ← [silence...]	No response
Command Y	→ ← [silence...]	No response
Command Y	→ ← [silence...]	No response
		Peripheral does not response within its allocated Non-Response Time.
RESET	→ ← [silence...]	Software Reset Peripheral in initialization routine
RESET	→ ← ACK	Peripheral operational again
POLL	→ ← JUST RESET	Peripheral indicates finished RESET processing
ACK	→	Peripheral initialization sequence is performed as recommended in each peripheral section.

- G. This diagram represents a situation where the peripheral is disconnected or goes offline. The controller should send a RESET command every 10 seconds to determine if, and when, the peripheral becomes active again.

Controller	Peripheral	Comment
Command X	→ ← Response	Normal response
Command Y	→ ← [silence...]	No response
Command Y	→ ← [silence...]	No response
Command Y	→ ← [silence...]	No response
		Peripheral does not response within its allocated Non-Response Time.
RESET	→ ← [silence...]	Software Reset Peripheral offline
RESET	→ ← [silence...]	Software Reset Peripheral offline
		Wait 10 seconds
RESET	→ ← [silence...]	Peripheral offline
		Wait 10 seconds
RESET	→ [silence...]	Peripheral offline
		Wait 10 seconds
RESET	→ [silence...]	Peripheral offline

2.6 File Transport Layer

The **File Transport Layer (FTL)** provides a method to send and/or receive high level information between peripherals or between a peripheral and the VMC. It is **not** intended to be used for standard vending credit and control functions. An example would be loading new validation parameters into a coin changer or bill validator.

Since the MDB/ICP interface is “driven” by the VMC, it has to be a network manager for all FTL data transfers. It acts as a temporary mailbox and data switch for FTL blocks; however, the information that is sent via FTL does not have to be interpreted by the VMC. The VMC simply uses the destination and source address information provided in the MDB/ICP command and response structure to forward the data to the proper recipient.

2.6.1 FTL Process Overview

If a peripheral needs to transfer data to another peripheral (or the VMC):

- The VMC must poll the peripheral,
- The peripheral must answer with a “REQUEST TO SEND”,
- The VMC must get approval to forward data (if necessary),
- The VMC requests the first data block,
- The VMC ACKs the first block and forwards to destination,
- The process repeats until all blocks are sent.

If the VMC needs to transfer data to a peripheral:

- The VMC must send a “REQUEST TO SEND”,
- The peripheral approves or denies the transfer request,
- If approved, the VMC sends the first data block,
- The peripheral ACKs the first data block,
- The process repeats until all blocks are sent.

If a peripheral (A) needs to request a transfer of data from another peripheral (B):

- The VMC must poll the peripheral A,
- Peripheral A must send a “REQUEST TO RECEIVE”,
- The VMC forwards the request to peripheral B,
- Peripheral B decides to honor the request or not,
- If approved, peripheral B sends the first data block,
- The VMC forwards the data block to peripheral A,
- The process repeats until all blocks are sent.

2.6.2 FTL Detailed VMC Operation

The VMC must act as a network manager, it is responsible for checking peripheral status and managing network resources as described below, it must:

- Be aware of which peripherals are active and support the FTL. If a file transfer is requested involving a peripheral that does not support it, the VMC should deny the transfer using RETRY/DENY defined later.
- Poll peripherals to become aware that a data transfer is requested.
- Read data blocks from selected peripherals.
- If VMC receives a NAK, it should attempt to finish current command/response up to 5 times. After that, it should abort file transfer as defined by the protocol.
- Send data blocks to destination device, if not the VMC itself.
- Repeat these steps for all data blocks, as needed.

2.6.3 FTL General Operation

- The FTL "session" would transfer a "file" using several "blocks". The "Dest" and "Src" are switched by the VMC directing each block to its destination.
- All responses can be sent immediately after receipt of command or the command can be ACK'ed and the response sent in a delayed fashion (meeting all appropriate time-outs). However, FTL responses must NOT be combined with responses to any other commands, at any time.
- File transfers less than 256 blocks are terminated by sending an empty data file (SEND BLOCK with no data). File transfers of exactly 256 blocks are terminated by block #FE followed by block #FF.
- It is recommended that files larger than one block:
 - 1) Include a CRC in their data. The transport layer is not responsible for checking for correct CRCs.
 - 2) Include a time out mechanism to prevent system dead locks. The transport layer is not responsible for checking for dead locked file transfers.
- To prevent a system dead lock, the VMC must poll other peripherals during all data transfers and service them accordingly.
- Since the VMC is not knowledgeable about the contents of the file transfer it should not disable any peripherals due to a transfer request. This will be the responsibility of the peripherals themselves. They may internally disable and report so to the VMC if possible, or they may just stop responding to the VMC until ready. The latter may cause the VMC to try to reset the peripheral.

2.6.4 FTL Command and Response Sets For All Components

The table below defines the VMC commands and peripheral responses that occur during an FTL data transfer. Note that the peripheral responses can either be immediate to the VMC's command or delayed and provided to a subsequent POLL. Definitions are provided on the following page.

Command / Response	VMC Cmd ¹	Resp	Source Data (bytes)	Destination Response
REQ TO SEND	α7/FE	1F	Dest (1) Src (1) File ID (1) Length (1) Control (1)	OK TO SEND or RETRY/DENY
OK TO SEND	α7/FD	1E	Dest (1) Src (1)	SEND BLOCK (repeated until whole file is transferred)
SEND BLOCK	α7/FC	1D	Dest (1) Block # (1) Data (1 to 31)	ACK
RETRY/DENY	α7/FB	1C	Dest (1) Src (1) Retry delay (1)	ACK
REQ TO RCV	α7/FA	1B	Dest (1) Src (1) File ID (1) Max Length (1) Control (1)	SEND BLOCK (repeated until whole file is transferred) or RETRY/DENY

Note 1: The α7 represents the address of the destination device (defined in Section 2.3) logically OR'd with a hexadecimal 0x07.

Dest **1 byte**

The destination address of the peripheral where the data block (**not the whole file**) is being sent to. All addresses refer to the standard MDB defined peripheral addresses as defined in Section 2.3. Note that 00000xxx (00H) will be used for the VMC. Examples are a changer (08H), audit system (18H), bill validator (30H), and universal satellite device #2 (48H).

Src **1 byte**

The source address of the peripheral where the data block (**not the whole file**) is being sent from. All addresses refer to the standard MDB defined peripheral addresses as defined in Section 2.3. Note that 00000xxx (00H) will be used for the VMC. Examples are the same as in the **Dest** above.

File ID **1 byte**

The type of information desired. NAMA will maintain a list of standard file ID's and a definition of what each file type means. Note that if a device responds with a "Retry delay" of FFH it should be interpreted that this device does not support the requested function.

Currently defined file IDs include:

00H: Manufacture ID information. This file must start with the manufactures three character manufactures code, anything after that would be up to the manufacture to define.

01H: DTS defined file. This file must follow the format defined in the EVA-DTS standard. This would include the DXS record as well as all data up to and including the DXE record.

0F0H to 0FFH: This range of files may be used for Manufacturer Specific information. The content and format of these files are left up to the manufacturer to define.

Additional ID proposals must be evaluated by the NAMA MDB/ICP technical standard committee.

(Max) Length **1 byte**

The total number of blocks that will (can) be included in the entire file. This byte should be used as a counter to determine the amount of data blocks to be transferred.

Control **1 byte**

This byte contains information that can be used by the VMC and peripherals to determine how the data transfer is conducted. Included controls are:

- b0: Reset after transfer. The receiving peripheral should reset itself after the file transfer is complete.
- b1: End of File. The last block of the current FTL session contains the end of this file. If clear (=0), then another FTL session will follow with additional blocks. If set (=1), then this is the last (or only) FTL session to be sent.
- b2 - b7: Not used, must be set to 0

Block # **1 byte**

The sequential number of this block, within the total file, that is being requested/sent. All data blocks must be identified by a block number, counting up from 0 (first block) to 255.

Data Block **1 to 31 byte(s)**

The actual data portion of the block. All data must fit into a 31 byte, or less, string. The standard MDB CHK byte will signify the end of block. (Peripherals will have to use inter-byte time out when receiving blocks from the VMC.) Knowledge of the contents of this data is only required by the source and destination devices.

Retry Delay **1 byte**

A time delay that the sender should wait before trying to re-send the entire data file again. If a device is not capable of receiving a file in its current state, this byte should represent the number of seconds before it will be ready to receive the data. If the device simply refuses to accept the file it must answer with a "Retry Never" signified by a 00H retry delay. If the device is not present, block synchronization is lost, or other failure mode arises a "Retry Never" should be used to abort/deny the current file transfer.

File Transport Layer Examples

Below are examples of data transfers between the VMC and a peripheral or between two different peripherals via the VMC.

SUCCESSFUL TRANSFER – VMC TO PERIPHERAL A			
Peripheral A	VMC	Peripheral B	Comments
	← REQ TO SEND ($\alpha 7/FE$)		Request to send "n" blocks
OK TO SEND (1E)	→		
	← ACK		
	← SEND BLOCK ($\alpha 7/FC$)		Repeated "n" times
ACK	→		

DENIED TRANSFER – VMC TO PERIPHERAL A			
Peripheral A	VMC	Peripheral B	Comments
	← REQ TO SEND ($\alpha 7/FE$)		
RETRY/00 (1C)	→		Denied
	← ACK		

SUCCESSFUL REQUEST – VMC TO PERIPHERAL A			
Peripheral A	VMC	Peripheral B	Comments
	← POLL (varies)		
REQ TO RCV (1B)	→		Request receive "n" blocks
	← ACK		
	← SEND BLOCK ($\alpha 7/FC$)		Repeated "n" times
ACK	→		

DENIED REQUEST – VMC TO PERIPHERAL A			
Peripheral A	VMC	Peripheral B	Comments
	← POLL (varies)		
REQ TO RCV (1B)	→		Request receive "n" blocks
	← ACK		
	← RETRY/00 ($\alpha 7/FB$)		Denied
ACK	→		

VMC ABORTED TRANSFER – VMC TO PERIPHERAL A			
Peripheral A	VMC	Peripheral B	Comments
	← REQ TO SEND (α7/FE)		Request to send “n” blocks
OK TO SEND (1E)	→		
	← ACK		
	← SEND BLOCK (α7/FC)		Repeated “n” times
ACK	→		
	← RETRY/00 (α7/FB)		Aborted!
ACK	→		

PERIPHERAL ABORT TRANSFER – VMC TO PERIPHERAL A			
Peripheral A	VMC	Peripheral B	Comments
	← REQ TO SEND (α7/FE)		Request to send “n” blocks
OK TO SEND (1E)	→		
	← ACK		
	← SEND BLOCK (α7/FC)		Aborted!
RETRY/00 (1C)	→		
	← ACK		

SUCCESSFUL TRANSFER – PERIPHERAL A TO VMC			
Peripheral A	VMC	Peripheral B	Comments
	← POLL (varies)		
REQ TO SEND (1F)	→		Request to send “n” blocks
	← ACK		
	← OK TO SEND (α7/FD)		
SEND BLOCK (1D)	→		Repeated “n” times
	← ACK		

DENIED TRANSFER – PERIPHERAL A TO VMC			
Peripheral A	VMC	Peripheral B	Comments
REQ TO SEND (1F)	← POLL (varies)		Request to send “n” blocks
	→		
	← ACK		
	← RETRY/00 (α7/FB)		Denied
ACK	→		

SUCCESSFUL TRANSFER – PERIPHERAL A TO PERIPHERAL B			
Peripheral A	VMC	Peripheral B	Comments
REQ TO SEND (1F)	← POLL (varies)		Request to send “n” blocks
	→		
	← ACK		
	REQ TO SEND (1F) (α7/FE)	→	
	ACK	← OK TO SEND (1E)	
	← OK TO SEND (α7/FD)		
SEND BLOCK (1D)	→		Repeated “n” times
	← ACK		
	SEND BLOCK (α7/FC)	→	
		← ACK	

DENIED TRANSFER – PERIPHERAL A TO PERIPHERAL B			
Peripheral A	VMC	Peripheral B	Comments
REQ TO SEND (1F)	← POLL (varies)		Request to send “n” blocks
	→		
	← ACK		
	REQ TO SEND (1F) (α7/FE)	→	
	ACK	← RETRY/00 (1C)	Denied
	← RETRY/00 (α7/FB)		
ACK	→		

SUCCESSFUL REQUEST - PERIPHERAL A TO PERIPHERAL B

Peripheral A	VMC	Peripheral B	Comments
REQ TO RCV (1B)	← POLL (varies)		Request receive "n" blocks
	→		
	← ACK		
	REQ TO RCV (α7/FA)	→	Repeated "n" times
		← SEND BLOCK (1D)	
	ACK	→	
	← SEND BLOCK (α7/FC)		
ACK	→		

DENIED REQUEST – PERIPHERAL A TO PERIPHERAL B

Peripheral A	VMC	Peripheral B	Comments
REQ TO RCV (1B)	← POLL (varies)		Request receive "n" blocks
	→		
	← ACK		
	REQ TO RCV (α7/FA)	→	Denied
		← RETRY/00 (1C)	
	ACK	→	
	← RETRY/00 (α7/FB)		
ACK	→		

PERIPHERAL A TRANSFER TO PERIPHERAL B – ABORTED BY A			
Peripheral A	VMC	Peripheral B	Comments
REQ TO SEND (1F)	← POLL (varies)		Request to send “n” blocks
	→		
	← ACK		
	REQ TO SEND (α7/FE)	→	
		← OK TO SEND (1E)	
	ACK	→	
SEND BLOCK (1D)	← OK TO SEND (α7/FD)		
	→		
	← ACK		
	SEND BLOCK (α7/FC)	→	
		← ACK	
	.		Repeated “n” times
	.		
RETRY/00 (1C)	← POLL (varies)		Aborted!
	→		
	← ACK		
	RETRY/00 (α7/FB)	→	
		← ACK	

PERIPHERAL A TRANSFER TO PERIPHERAL B – ABORTED BY B			
Peripheral A	VMC	Peripheral B	Comments
REQ TO SEND (1F)	← POLL (varies)		Request to send “n” blocks
	→		
	← ACK		
	REQ TO SEND (α7/FE)	→	
		← OK TO SEND (1E)	
	ACK	→	
SEND BLOCK (1D)	← OK TO SEND (α7/FD)		
	→		
	← ACK		
	SEND BLOCK (α7/FC)	→	
		← ACK	
	.		Repeated “n” times
	.		
	.		
SEND BLOCK (1D)	← POLL (varies)REQ BLOCK (α7/FD)		
	→		
	← ACK		
	SEND BLOCK (α7/FC)	→	
		← RETRY/00 (1C)	Aborted!
	ACK	→	
ACK	← RETRY/00 (α7/FB)		
	→		

Section 3

Bus Timing

3.1 Timing Definitions

Baud rate	=	The rate of bit transfer per second.
t inter-byte (max.)	=	The maximum time allowed between bytes in a block transmission.
t response (max.)	=	The maximum time any device, master or peripheral, will take to respond to a valid communication.
t break (VMC)	=	The minimum time of the Bus Reset signal sent by the VMC to reset all peripherals.
t setup	=	The minimum set-up time before the VMC attempts to communicate after a reset signal. Peripheral devices may choose to not respond for up to the non-response time defined in each peripheral section.

3.2 Timing Specifications

Baud Rate	=	9600 +1%/-2% NRZ
t inter-byte (max.)	=	1.0 mS
t response (max.)	=	5.0 mS
t break (min.)	=	100 mS
t setup (min.)	=	200 mS

NOTE: All peripherals have the option of not responding to the VMC. Non-response timing is defined in the peripheral specification.

3.3 Timing Diagram

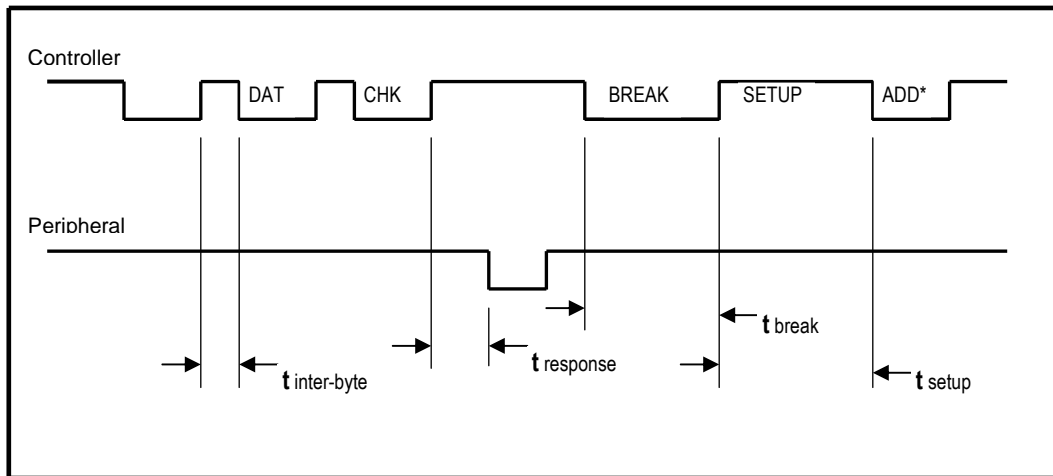

NOTE: * indicates that the mode bit is set

Section 4

Hardware Specification

4.1 Bus Power Supply Definition

The information below defines the minimum VMC voltage output. The actual current ratings per peripheral will be defined in their respective sections.

Power supply filtering is optional, therefore if a peripheral requires more power, or tighter regulation, they may elect to supply their own power, or filtering, from available sources elsewhere in the machine.

VMC Voltage Output:

Minimum	=	20 VDC rms.(rectified and optionally filtered)
Nominal	=	34 VDC unreg.(rectified and filtered) 24 VDC rms.(rectified only)
Maximum	=	42.5* VDC(ripple voltage upper limit) * High line input may allow 45 VDC peak (max.).

4.2 Bus Transmitter / Receiver Specification

The following section describes the 5V, optically isolated, current loop system between the Master and the Slave.

VMC Master:

Transmit:

Minimum source current (active):	100 mA @ 4V
Maximum leakage current (inactive):	100 uA

- NOTES:**
- 1) The transmit line must be able to withstand a short while in the active mode.
 - 2) 15 mA should be added for each peripheral over six.

Receive:

Minimum input current (active):	15 mA @ 1V
Maximum input current (inactive):	1 mA

Peripheral Slave:**Receive:**

Maximum input current (active):	15 mA @ 4V
Maximum input current (inactive):	100 uA

Transmit:

Minimum sink current (active):	15 mA @ 1V
Maximum leakage current (inactive):	30 uA

4.3 Connector Specification

Connector assemblies supplied by the NAMA approved suppliers, noted in Section 4.3.6, are intermateable and meet or exceed the minimum requirements identified in Sections 4.3.1, 4.3.2, 4.3.3, 4.3.4, and 4.3.5 when tested in the mated condition. NAMA must approve any supplier changes to the fit, form, or function. Discrete components, i.e. contacts, are not required to be inter-changeable between supplier products.

4.3.1. Material

- 4.3.1.1. Terminal: Phosphor Bronze
- 4.3.1.2. Plating: Tin or Tin/Lead
- 4.3.1.3. Housing: UL 94V-2 nylon

4.3.2. Ratings

Section	Item	Requirement
4.3.2.1.	Rated Voltage (Max)	600 Volts AC
4.3.2.2.	Maximum Rated Current (Six Circuit)	7 Amps
4.3.2.3.	Ambient Temperature Range (including terminal T-rise)	-40°C to +105°C

4.3.3. Electrical Performance

Section	Item	Test Condition	Requirement
4.3.3.1.	Contact Resistance	Mate Connectors, measure by dry circuit, 20 mV max., 10 mA. Wire resistance shall be removed from the measured value.	10 mΩ Max.
4.3.3.2.	Insulation Resistance	Mate Connectors, apply 500V DC between adjacent terminal or ground.	1000 MΩ Min.
4.3.3.3.	Dielectric Strength	Mate Connectors, apply 1500V AC for 1 minute between adjacent terminal or ground.	No Breakdown.

4.3.4. Mechanical Performance

Section	Item	Test Condition	Requirement		
4.3.4.1.	Insertion and Withdrawal Force	Insert and withdraw connectors at a speed rate of 25 +/- 3mm / minute.	Noted Below		
		6 Pos Insertion Max.	6 Pos Withdrawal Min.		
		Initial	30 th cycle	Initial	30 th cycle
		41.2 N	38.2 N	2.9 N	2.4 N
4.3.4.2.	Crimping Pull Out Force	Mount the crimped terminal, apply axial force on the wire at a rate of 25 +/- 3mm minute. 16 AWG 18 AWG 20 AWG 22 AWG 24 AWG 26 AWG 28 AWG	88 N Min. 88 N Min. 59 N Min. 39 N Min. 29 N Min. 20 N Min. 10 N Min.		
4.3.4.3.	Terminal Insertion Force	Insert the crimped terminal into the housing.	15 N Max.		
4.3.4.4.	Terminal/Housing Retention Force	Apply axial pull out force at the speed rate of 25 +/- 3mm / minute.	22 N Min.		
4.3.4.5.	Locking / Unlocking Force	Measure force to lock & unlock connector housings (without contacts) at a rate of 25 +/- 3mm / minute.	Lock: 30 N Max. Unlock: 50 N Min.		

4.3.5. Environmental Performance

Section	Item	Test Condition	Requirement	
4.3.5.1.	Repeated Insertion / Withdrawal	When mated up to 30 cycles repeatedly by rate of 10 cycles per minute.	Contact Resistance	20 mΩ Max.
4.3.5.2.	Temperature Rise	Carrying rated current load.	30°C Rise Max.	
4.3.5.3.	Vibration	Amplitude: 1.5mm P-P Sweep Time: 10-55-10 Hz in 1 minute. Duration: 2 hours in each X,Y,Z axis.	Appearance	No Damage
			Contact Resistance	20 mΩ Max.
			Discontinuity	1 μ sec. Max.
4.3.5.4.	Shock	50 G; 3 strokes in each X,Y,Z axis.	Appearance	No Damage
			Contact Resistance	20 mΩ Max.
			Discontinuity	1 μ sec Max.
4.3.5.5.	Heat Resistance	105 +/- 2°C, 96 hours	Appearance	No Damage
			Contact Resistance	20 mΩ Max.
4.3.5.6.	Cold Resistance	-40 +/- 3°C, 96 hours	Appearance	No Damage
			Contact Resistance	20 mΩ Max.
4.3.5.7.	Humidity	Temperature: 60 +/- 2°C Relative Humidity: 90% - 95% Duration: 96 hours	Appearance	No Damage
			Contact Resistance	20 mΩ Max.
			Dielectric Strength	No Breakdown
			Insulation Resistance	1000 MΩ Min.
4.3.5.8.	Temperature Cycling	5 Cycles: a) - 55°C ; 30 Minutes b) 105°C ; 30 Minutes	Appearance	No Damage
			Contact Resistance	20 mΩ Max.
4.3.5.9.	Salt Spray	48 +/- 4 hours exposure to salt spray from 5 +/- 1% solution at 35 +/- 2°C.	Appearance	No Damage
			Contact Res.	20 mΩ Max.
4.3.5.10	SO ₂ Gas	24 hour exposure to 50 +/- 5 ppm SO ₂ gas at 40 +/- 2°C.	Appearance	No Damage
			Contact Res.	Max.

4.3.6 Approved Suppliers and Part Numbers

4.3.6.1. Suppliers

Molex : Mini-Fit, Jr.™ Product
AMP: AMP-DUAC™ Product

4.3.6.2. Peripherals

Connector: Six (6) Circuit Receptacle Housing
Molex 39-01-2060
AMP P/N 106527-6

Terminals: Female Contacts (sockets), Tin
Molex 39-00-0065
AMP P/N 106528-2 or 106529-2

Strain Relief: The strain relief shall not exceed a Maximum Form Factor of 0.85 inch wide x 0.75 inch high x 1.90 inch long, excluding integrated hinges and wire ties.

Molex 15-04-0296
AMP P/N 1375618-1

4.3.6.3. Bus Harness

Connector: Six (6) Circuit Plug Housing
Molex 39-01-2061
AMP P/N 794550-6 or 794542-6

Terminals: Male Contacts (pins), Tin
Molex 39-00-0067
AMP P/N 794578-1 or 794576-1

4.3.6.4. VMC Connector (Direct PCB Mount)

Vertical Header: Male Contacts (pins), Tin
Molex 39-28-1063
AMP P/N 794664-6

Right Angle Header: Male Contacts (pins), Tin
Molex 39-30-1060
AMP P/N 794448-1

4.3.6.5. Approved Parts – Alternate Form Factors

Select applications may require connector configurations with alternate form factors. Alternate form factor connectors may be used provided they are:

- provided by the Approved Suppliers listed
- part of the Approved Supplier Product Family portfolio
- intermateable with the approved connector part numbers listed
- meet the performance objectives set forth in this specification

Connector Pin-out:

- Line 1 - 34 VDC
- Line 2 - DC Power Return
- Line 3 - N/C
- Line 4 - Master Receive
- Line 5 - Master Transmit
- Line 6 - Communications Common

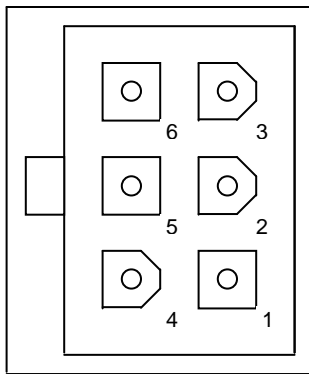

Peripheral Connector
Face View
Receptacle
(Sockets)

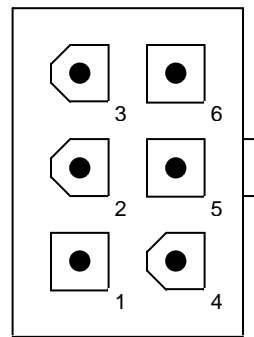

VMC / Bus Connector
Face View
Header
(Pins)

4.4 Example Schematic

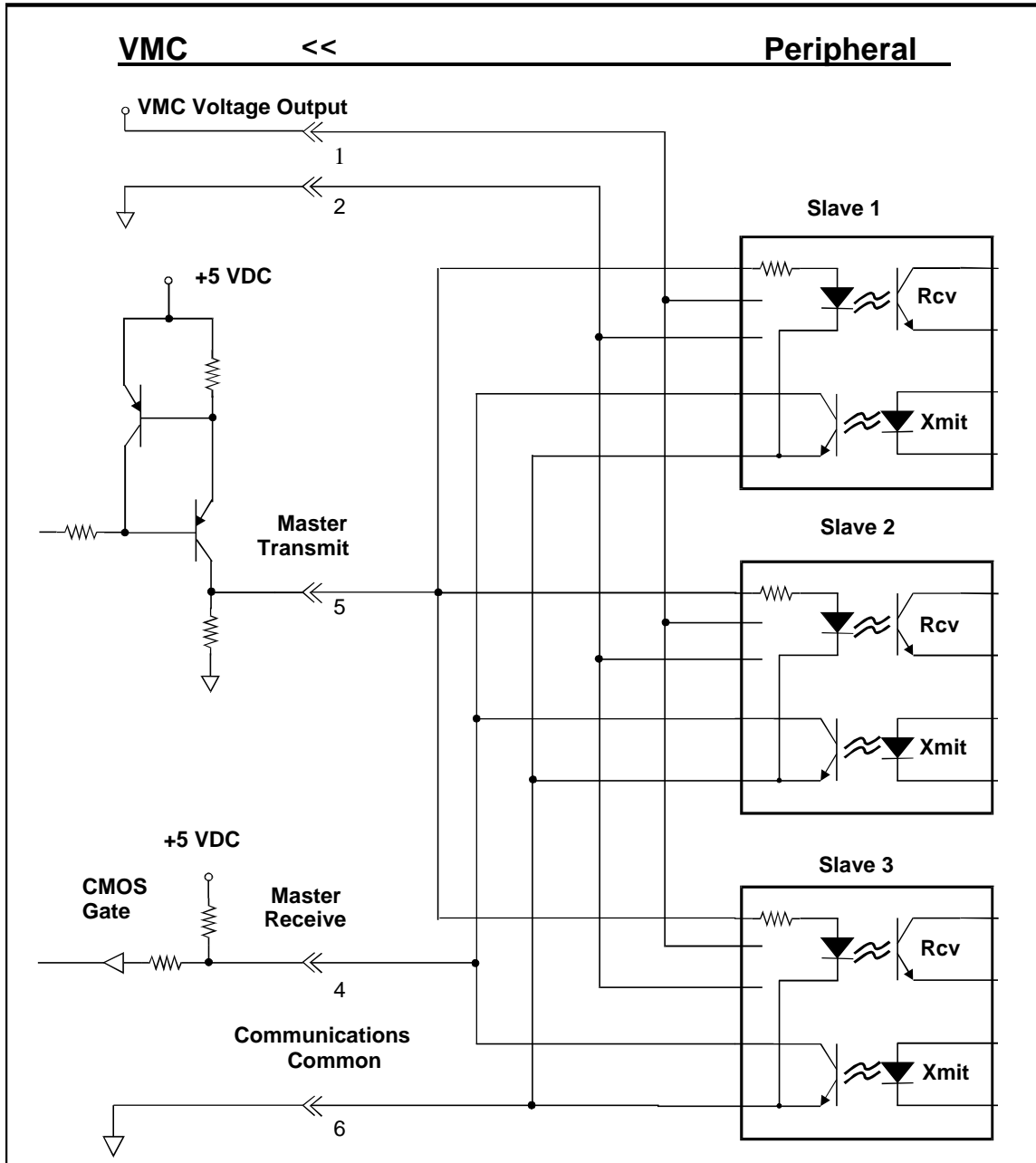

Section 5

Coin Acceptor/Changer

VMC/Peripheral Communication Specifications

5.1 Introduction

This section defines the communication bytes sent and received by a coin accepting device (“Changer”). As defined in Section 2.3, the changer’s address is 00001xxxB (08H).

Unless stated otherwise, all information is assumed to be in a binary format.

There are currently two levels of support defined for the coin mechanism interface, Level 2 and Level 3. The level of coin mechanism operation is sent to the VMC in the response to the STATUS command (defined later in this section). The following paragraphs will define how a VMC should differentiate between each level.

Level 2 Changers

For level 2 changers, VMC operation consists of monitoring inputs from the coin mechanism, accumulating credit, issuing a coin acceptance disable command when appropriate, and issuing appropriate payout commands based on the VMC resident payout algorithms and escrow rules.

Level 3 Changers

For level 3 changers, VMC operation is the same as defined above for level 2, with the addition of the EXPANSION command and its implications (defined later in this section). The VMC has the option of sending the EXPANSION command to the coin mechanism to determine the coin mechanism’s manufacturer code, serial number, model/tuning revision, software version, and optional features. Based on the optional feature information the VMC will determine the appropriate operating mode (in other words, modes that both the coin mechanism and the VMC can support), enable any appropriate coin mechanism features by sending an appropriate feature enable command back to the coin mechanism, and enter the proper operating mode. This technique allows all VMCs and peripherals to accommodate existing feature capabilities and provides a means for upgrading Level 3 equipment.

5.2 VMC Commands

<u>Command</u>	<u>Hex Code</u>	<u>Description</u>
RESET	08H	Command for changer to self-reset
SETUP *	09H	Request for changer setup information.
TUBE STATUS	0AH	Request for changer tube status.
POLL	0BH	Request for changer activity status.
COIN TYPE	0CH	Signifies coin types accepted and allowable coin dispensing. This command is followed by setup data. See command format section.
DISPENSE	0DH	Command to dispense a coin type. Followed by coin type to dispense. See command format section.
EXPANSION COMMAND	0FH	Command to allow addition of features and future enhancements. Changers at feature level 2 do not support this command.

NOTE: An EXPANSION command is always followed by a “sub-command.” This command allows for feature additions.

* In Version 1.0 & 2.0, **SETUP** was called **STATUS**.

5.3 VMC Command Format

<u>VMC Command</u>	<u>Code</u>	<u>VMC Data</u>
RESET	08H	No data bytes

This command is the vehicle that the VMC should use to tell the changer that it should return to its default operating mode. With the exception of the ACK response, it should abort all communication and disable all acceptance until otherwise instructed by the VMC.

The following initialization sequence is recommended for all new VMCs designed after July, 2000. It should be used after “power up”, after issuing the RESET command, after issuing the Bus Reset (pulling the transmit line “active” for a minimum of 100 mS), or anytime a POLL command results in a “JUST RESET” response (i.e., peripheral self resets).

POLL – 08h

To obtain “JUST RESET” response

SETUP – 09h

To obtain changer level and configuration information

EXPANSION IDENTIFICATION – 0F 00h (Level 03+ only)

To obtain additional changer information and options

EXPANSION FEATURE ENABLE – 0F 01h (Level 03+ only)

To enable desired options

EXPANSION SEND DIAG STATUS – 0F 05h (Level 03+ & option b1 only)

To request the changer to report its current state of operation

TUBE STATUS – 0Ah (Note 1)

To obtain tube status / change information

COIN TYPE – 0Ch

To enable desired coin acceptance and disable manual coin payout if desired

Note 1 – A minimum 500 msec delay is required between a reset (regardless of type) and the first **TUBE STATUS** command for certain models of the existing MDB coin changer field base.

<u>VMC Command</u>	<u>Code</u>	<u>Changer Response Data</u>
SETUP	09H	23 bytes: Z1 - Z23

Z1 = Changer Feature Level - 1 byte

Indicates the feature level of the changer. This will distinguish the changers feature level to the VMC. Current defined levels:

Level 2: Supports "core" command set. These are: RESET, STATUS, TUBE STATUS, POLL, COIN TYPE, and DISPENSE. (Z1 = 02h)

Level 3: Supports level two and the EXPANSION command addition changer model number, manufacturer code, turning revision, etc. See the details of EXPANSION command later in this document. (Z1=03h)

Z2 - Z3 = Country / Currency Code - 2 bytes

The packed BCD country / currency code of the changer can be sent in two different forms depending on the value of the left most BCD digit.

If the left most digit is a 0, the International Telephone Code is used to indicate the country that the changer is set-up for. For example, the USA code is 00 01H (Z2 = 00 and Z3 = 01).

If the left most digit is a 1, the latest version of the ISO 4217 numeric currency code is used (see Appendix A1). For example, the code for the US dollar is 18 40H (Z2 = 18 and Z3 = 40) and for the Euro is 19 78 (Z2 = 19 and Z3 = 78).

All new designs after July, 2000 must use the ISO 4217 numeric currency codes as listed in Appendix A1.

Z4 = Coin Scaling Factor - 1 byte

All accepted coin values must be evenly divisible by this number. For example, this could be set to 05H for the USA nickel.

Z5 = Decimal Places - 1 byte

Indicates the number of decimal places on a credit display. For example, this could be set to 02H in the USA.

Z6 - Z7 = Coin Type Routing - 2 bytes

Indicates what coin types can be routed to the Changer's tubes.

b15 b14 b13 b12 b11 b10 b9 b8 | b7 b6 b5 b4 b3 b2 b1 b0
Z6 Z7

Bit is set to indicate a coin type can be routed to the tube. Valid coin types are 0 to 15.

Z8 - Z23 = Coin Type Credit - 16 bytes

Indicates the value of coin types 0 to 15. Values must be sent in ascending order. This number is the coin's monetary value divided by the coin scaling factor. Unused coin types are sent as 00H. Unsent coin types are assumed to be zero. It is not necessary to send all coin types. Coin type credits sent as FFH are assumed to be vend tokens. That is, their value is assumed to worth one vend.

The bytes position in the 16 byte string indicates the coin type(s). For example, the first byte sent would indicate the value of coin type 0, the second byte sent would indicate the value of coin type 1, and so on. For example, the USA coin types may be; Coin type 0 = nickel, Coin type 1 = dime, Coin type 2 = quarter, Coin type 3 = dollar.

<u>VMC Command</u>	<u>Code</u>	<u>Changer Response Data</u>
TUBE STATUS	0AH	18 bytes: Z1 - Z18

Z1 - Z2 = Tube Full Status - 2 bytes

Indicates status of coin tube for coin types 0 to 15.

b15 b14 b13 b12 b11 b10 b9 b8 | b7 b6 b5 b4 b3 b2 b1 b0
Z1 Z2

A bit is set to indicate a full tube. For example, bit 7 = set would indicate the tube for coin type 7 is full.

Z3 - Z18 = Tube Status - 16 bytes

Indicates the greatest number of coins that the changer "knows" definitely are present in the coin tubes. A bytes position in the 16 byte string indicates the number of coins in a tube for a

particular coin type. For example, the first byte sent indicates the number of coins in a tube for coin type 0. Unsent bytes are assumed to be zero. For tube counts greater than 255, counts should remain at 255.

NOTE: If a changer can detect a tube jam, defective tube sensor, or other malfunction, it will indicate the tube is "bad" by sending a tube full status and a count of zero for the malfunctioning coin type.

<u>VMC Command</u>	<u>Code</u>	<u>Changer Response Data</u>
POLL	0BH	16 bytes: Z1 - Z16

Z1 - Z16 = Changer Activity - 16 bytes

Indicates the changer activity. If there is nothing to report, the changer should send only an ACK. Otherwise, the only valid responses are:

Coins Dispensed Manually:

<u>Z1</u>	<u>Z2</u>
(1yyyxxxx)	(zzzzzzzz)

yyy	=	The number of coins dispensed.
xxxx	=	The coin type dispensed (0 to 15)
zzzzzzzz	=	The number of coins in the tube.

Coins Deposited:

<u>Z1</u>	<u>Z2</u>
(01yyxxxx)	(zzzzzzzz)

yy	=	Coin routing. 00: CASH BOX 01: TUBES 10: NOT USED 11: REJECT
----	---	---

xxxx	=	Coin type deposited (0 to 15).
------	---	--------------------------------

zzzzzzzz	=	The number of coins in the tube for the coin type accepted.
----------	---	---

Status:

(00000001) =	Escrow request ¹ - An escrow lever activation has been detected.
--------------	---

(00000010) =	Changer Payout Busy ² - The changer is busy activating payout devices.
--------------	---

(00000011) =	No Credit ¹ - A coin was validated but did not get to the place in the system when credit is given.
(00000100) =	Defective Tube Sensor ¹ - The changer has detected one of the tube sensors behaving abnormally.
(00000101) =	Double Arrival ¹ - Two coins were detected too close together to validate either one.
(00000110) =	Acceptor Unplugged ² - The changer has detected that the acceptor has been removed.
(00000111) =	Tube Jam ¹ - A tube payout attempt has resulted in jammed condition.
(00001000) =	ROM checksum error ¹ - The changers internal checksum does not match the calculated checksum.
(00001001) =	Coin Routing Error ¹ - A coin has been validated, but did not follow the intended routing.
(00001010) =	Changer Busy ² - The changer is busy and can not answer a detailed command right now.
(00001011) =	Changer was Reset ¹ - The changer has detected an Reset condition and has returned to its power-on idle condition.
(00001100) =	Coin Jam ¹ - A coin(s) has jammed in the acceptance path.
(00001101) =	Possible Credited Coin Removal ¹ – There has been an attempt to remove a credited coin.

Note:

- changers must have a means to disable this code due to potential older VMC issues.
- virtually all VMCs designed prior to this code's introduction (10/16/02) will not support it.
- It is a vending machine system issue as to what is done when this code is received.

Slug:

(001xxxx) =	xxxx is the number of slugs since the last activity.
-------------	--

NOTES: The Changer may send several of one type activity*, up to 16 bytes total. This will permit zeroing counters such as slug, inventory, and status.

- 1 Sent once each occurrence
- 2 Sent once each POLL

* Type activity is defined as Coins Dispensed Manually, Coins Deposited, Status, and Slug. All may be combined in a response to a POLL command providing the total number of bytes does not exceed 16. Note that Coins Dispensed Manually and Coins Deposited are dual byte codes.

File Transport Layer POLLED responses:

Note that all FTL responses are defined in Section 2.6. For the coin changer, the source address will always be the changer (08H) as defined in Section 2.3.

Z1

1B	REQ TO RCV	<p>The coin changer is requesting to receive data from a device or VMC.</p> <p>Z2 = Destination address of response Z3 = Source address of response (08H) Z4 = File ID Z5 = Maximum length Z6 = Control</p>
1C	RETRY/DENY	<p>The coin changer is requesting a device or VMC to retry or deny the last FTL command.</p> <p>Z2 = Destination address of response Z3 = Source address of response (08H) Z4 = Retry delay</p>
1D	SEND BLOCK	<p>The coin changer is sending a block of data (maximum of 31 bytes) to a device or VMC.</p> <p>Z2 = Destination address of data Z3 = Block # Z4-Z34 = Data (maximum of 31 bytes)</p>
1E	OK TO SEND	<p>The coin changer is indicating that it is OK for a device or VMC to send it data.</p> <p>Z2 = Destination address of response Z3 = Source address of response (08H)</p>
1F	REQ TO SEND	<p>The coin changer is requesting to send data to a device or VMC.</p> <p>Z2 = Destination address of response Z3 = Source address of response (08H) Z4 = File ID Z5 = Maximum length Z6 = Control</p>

<u>VMC Command</u>	<u>Code</u>	<u>VMC Data</u>
COIN TYPE	0CH	4 bytes: Y1 - Y4

Y1 - Y2 = Coin Enable - 2 bytes

b15	b14	b13	b12	b11	b10	b9	b8		b7	b6	b5	b4	b3	b2	b1	b0
Y1																Y2

A bit is set to indicate a coin type is accepted. For example, bit 6 is set to indicate coin type 6, bit 15 is set to indicate coin type 15, and so on. To disable the changer, disable all coin types by sending a data block containing 0000H. All coins are automatically disabled upon reset.

Y3 - Y4 = Manual Dispense Enable - 2 bytes

b15	b14	b13	b12	b11	b10	b9	b8		b7	b6	b5	b4	b3	b2	b1	b0
Y3																Y4

A bit is set to indicate dispense enable. For example, bit 2 is set to enable dispensing of coin type 2. This command enables/disables manual dispensing using optional inventory switches. All manual dispensing switches are automatically enabled upon reset.

<u>VMC Command</u>	<u>Code</u>	<u>VMC Data</u>
DISPENSE	0DH	1 byte: Y1
	b7 b6 b5 b4 b3 b2 b1 b0	
		Y1

Bits b3, b2, b1, b0 indicate coin type to be dispensed. Valid codes are 0H to FH to indicate coin types 0 to 15.

Bits b7, b6, b5, b4 indicate the number of coins to be dispensed.

NOTE 1: If two coin types have the same value, the highest coin type should be paid out first.

NOTE 2: There is no defined limit on how long the actual dispense takes since the command allows for up to 15 coins to be paid out. The payout cycle begins when the changer ACKs the VMC's DISPENSE (0DH) command. This cycle typically lasts a minimum of 100 mS and ends when the changer stops dispensing the desired number of coins. VMCs should monitor the Changer Payout Busy response to the POLL command to determine when the entire payout cycle is completed.

However, it must be noted that other than ACKing the DISPENSE (0DH) command, the changer does not have to respond during the payout cycle provided the payout cycle is less than the changer's non-response time and the changer starts responding again prior to the end of the non-response time. Thus, it is acceptable for the changer to never report Changer Payout Busy, but simply start ACKing the POLL commands upon completion of a payout cycle provided the non-response time has not been exceeded.

LEVEL THREE CAPABILITIES - EXPANSION COMMAND

The following describes the currently defined expansion commands.

Sub-command 00H is used for a changer that has the capability of reporting model number, serial number, and so on.

<u>VMC Command</u>	<u>Code</u>	<u>Sub-Command</u>	<u>Changer Response Data</u>
EXPANSION COMMAND	0FH	00H IDENTIFICATION	33 bytes: Z1 - Z33

Z1 - Z3 = Manufacturer Code - 3 bytes
Identification code for the equipment supplier. Sent as ASCII characters. Currently defined codes are listed in the **EVA** document entitled "**European Vending Association Data Transfer Standard**" (**EVA-DTS**), the Audit Data Lists section, sub-section 2, "Manufacturer Codes".

Z4 - Z15 = Serial Number - 12 bytes

Factory assigned serial number. All bytes must be sent as ASCII characters, zeros (30H) and blanks (20H) are acceptable.

Z16 - Z27 = Model #/Tuning Revision - 12 bytes

Manufacturer assigned model number and tuning number. All bytes must be sent as ASCII characters, zeros (30H) and blanks (20H) are acceptable. Each manufacturer should include information concerning the changer tuning revision.

Z28 - Z29 = Software Version - 2 bytes

Current software version. Must be sent in packed BCD.

Z30 - Z33 = Optional Features - 4 bytes

Each of the 32 bits indicate an optional features availability. If the bit is set the feature is available. Bits should be sent in descending order, i.e. bit 31 is sent first and bit 0 is sent last. Currently defined options are:

b0 - Alternative Payout method. This method allows changer designs that determine change payout. That is, the payout algorithm may reside in the changer instead of the VMC.

- b1 - Extended Diagnostic command supported. This command allows the VMC to request diagnostic status of the coin changer.
- b2 - Controlled Manual Fill and Payout commands supported. These commands allows the VMC to request the number of coin inserted or dispensed while the changer was in a controlled manual fill or payback mode.
- b3 - File Transport Layer (FTL) supported as defined in Section 2.6.
- b4 - b31 Available for future use

<u>VMC Command</u>	<u>Code</u>	<u>Sub-Command</u>	<u>VMC Data</u>
EXPANSION COMMAND	0FH	01H FEATURE ENABLE	4 bytes: Y1 - Y4

This command is used to enable each of the optional features defined in Z30-Z33 above. To enable a feature a bit is set to one. **All optional features are disabled after reset.**

<u>VMC Command</u>	<u>Code</u>	<u>Sub-command</u>	<u>VMC Data</u>	<u>Changer Response</u>
EXPANSION COMMAND (Alternative Payout)	0FH	02H PAYOUT	Y1	None

Y1 = Value of coins to be paid out - 1 byte

This value is expressed as the number of coin scaling factors that would sum to the value. For example, in a USA system using a scaling factor of 05, if the change to be paid out is 75 cents, then Y1 will equal fifteen. That is, the sum of fifteen nickels equal 75 cents. The coin changer will determine which actual denominations of coins will be paid out. In the 75 cent example, the coins may be 3 quarters; or, 7 dimes & 1 nickel; or, 2 quarters & 2 dimes & 1 nickel, etc.

<u>VMC Command</u>	<u>Code Sub-command</u>	<u>VMC Data</u>	<u>Changer Response</u>
EXPANSION COMMAND (Alternative Payout)	0FH 03H PAYOUT STATUS	None	16 bytes: Z1-Z16

Z1 - Z16 = Number of each coin type paid out - 16 bytes

This is the changer's response to the last VMC Alternative PAYOUT command (0FH-02H). Bytes are sent in ascending order of coin types. A bytes position in the string indicates the coin type. That is, byte one is the number of coins for coin type 1, byte two is the number of coins for coin type two, and so on. Unsent bytes are assumed to be zero.

The changer clears payout data after an ACK response from the VMC.

The VMC should compare the value of the coins paid out to the (0FH-02H) Alternative PAYOUT command's Y1.

- NOTES:**
- 1) If the changer's payout is busy it will respond to the Alternative PAYOUT STATUS command with an ACK only.
 - 2) If no coins have been paid out, at least one zero valued data byte must be sent.
 - 3) There is no defined limit on how long the actual payout takes. See Note 2 under the DISPENSE (0DH) command.

<u>VMC Command</u>	<u>Code Sub-command</u>	<u>Changer Response Data</u>
EXPANSION COMMAND (Alternative Payout)	0FH 04H PAYOUT VALUE POLL	1 byte: Z1

Z1 = Changer Payout Activity - 1 byte

An interval value (scaled) which indicates the amount of paid out change since the previous PAYOUT VALUE POLL (or between the initial Alternative PAYOUT command (0FH-02H) and the first PAYOUT VALUE POLL).

An 00H response indicates no coins were paid out since the previous PAYOUT VALUE POLL (or the initial Alternative PAYOUT command (0FH-02H)).

An ACK only indicates that the change payout is finished. This should be followed by the PAYOUT STATUS command (0FH-03H) to obtain the complete payout data.

NOTE: The initial intent of this command is to determine the amount of change paid out so that the credit display can be decremented as coins are dispensed.

<u>VMC Command</u>	<u>Code</u>	<u>Sub-Command</u>	<u>Changer Response Data</u>
EXPANSION COMMAND	0FH	05H SEND DIAGNOSTIC STATUS	2 bytes: Z1-Z2

Send Current Diagnostic Status - This command requests the changer to report its current state of operation. The VMC should periodically transmit the command approximately every 1 to 10 seconds.

Z1-Z2 = Current changer diagnostic information

The changer reports its current state of operation in a 2 byte code. Z1 is the main code and Z2 is the sub-code. The code is reported as long as the condition exists and stops being reported as soon as the condition does not exist. Multiple 2 byte codes may be sent in response to a single command which could result in a maximum of eight 2 byte codes (16 bytes total).

The following tables identify the currently defined extended diagnostic codes:

Z1 / Z2	Status	Cause(s) of Status / Error
01 / 00	Powering up	Changer powering up / initialization
02 / 00	Powering down	Changer powering down
03 / 00	OK	Changer fully operational and ready to accept coins
04 / 00	Keypad shifted	MODE key pressed and held so that LED flashes indicating keypad in shifted state. Reverts to normal mode if no key pressed for 15 seconds
05 / 10	Manual Fill / Payout active	Manual Fill or Manual Payout mode of operation in progress (under control of the changer). This response must be reported at least once to allow the VMC to request a manual fill or manual payout report.
05 / 20	New Inventory Information Available	Changer not in Manual inventory mode, but new inventory information available.
06 / 00	Inhibited by VMC	All coin acceptance inhibited at request of VMC, possibly due to product dispenser jams, completely sold out, etc.
10 / Z2	General changer error	Z2 defined as: 00 Non specific error. 01 Check sum error #1. A check sum error over a particular data range of configuration field detected. 02 Check sum error #2. A check sum error over a secondary data range or configuration field detected. 03 Low line voltage detected. The changer has disabled acceptance or payout due to a low voltage condition.

Z1 / Z2	Status	Cause(s) of Status / Error
11 / Z2	Discriminator module error	Z2 defined as: 00 Non specific discriminator error. 10 Flight deck open. 11 Escrow Return stuck open. 30 Coin jam in sensor. 41 Discrimination below specified standard. 50 Validation sensor A out of range. The acceptor detects a problem with sensor A. 51 Validation sensor B out of range. The acceptor detects a problem with sensor B. 52 Validation sensor C out of range. The acceptor detects a problem with sensor C. 53 Operating temperature exceeded. The acceptor detects the ambient temperature has exceeded the changer's operating range, thus possibly affecting the acceptance rate. 54 Sizing optics failure. The acceptor detects an error in the sizing optics.
12 / Z2	Accept gate module error	Z2 defined as: 00 Non specific accept gate error. 30 Coins entered gate, but did not exit. 31 Accept gate alarm active. 40 Accept gate open, but no coin detected. 50 Post gate sensor covered before gate opened.
13 / Z2	Separator module error	Z2 defined as: 00 Non specific separator error 10 Sort sensor error. The acceptor detects an error in the sorting sensor.
14 / Z2	Dispenser module error	Z2 defined as: 00 Non specific dispenser error.
15 / Z2	Coin Cassette / tube module error	Z2 defined as: 00 Non specific cassette error. 02 Cassette removed. 03 Cash box sensor error. The changer detects an error in a cash box sensor. 04 Sunlight on tube sensors. The changer detects too much ambient light on one or more of the tube sensors.

Diagnostic Status EVA-DTS Correlation

The Extended Diagnostic information reported may be used by the vending machine controller as desired (i.e., service mode displays); however, **EVA-DTS** data elements could also be used for reporting to a host system. Examples are:

- o Via a translation of the Z1/Z2 code to one of the **Fault Lists** as described in Section 10 of the **EVA-DTS**.
- o Via the EA201 Event Identification element with the format **EAXxyy** where xx = Z1 and yy = Z2.
- o Via a customer / manufacture specific coding scheme using the **MA5xx** fields.

VMC Command	Code	Sub-Command	Changer Response Data
EXPANSION	0FH	06H	16 bytes Z1-Z16
COMMAND		SEND CONTROLLED MANUAL FILL REPORT	

Send Controlled Manual Fill Report - This command requests the changer to report the number of coins inserted during a changer controlled manual fill (controlled bulk fill) mode. While in this mode, the changer must not report coins inserted in response to the **POLL** command.

Z1-Z16 = number of controlled manual mode filled coins (by coin type)

A single byte is reported for each coin type, 0 to 15. For example, Z1 = number of coins of coin type 0 added in a controlled manual fill mode. Any amount above 255 will be reported as 255, i.e. it will reach a maximum limit.

Only coin types *supported* are required to be reported. Counts for unspent coins types will be assumed to be unchanged.

Notes: After power on, changer reset, closing of the machine door, or a change in controlled manual fill status in the changer (changer indicated it was in controlled manual fill mode via CM0510 then changed to any other state) the machine should request the controlled manual coin fill data from the changer using the above command.

See EVA-DTS correlation at end of **SEND CONTROLLED MANUAL PAYOUT REPORT** (0F-07H) command.

VMC Command	Code	Sub-Command	Changer Response Data
EXPANSION COMMAND	0FH	07H	16 bytes Z1-Z16
	SEND CONTROLLED MANUAL PAYOUT REPORT		

Send Controlled Manual Payout Report - This command requests the changer to report the number of coins dispensed during a changer controlled manual payout (controlled bulk dispense) mode. Note that this does not include the coins dispensed via the individual dispense switches.

If the new Controlled Manual Fill / Payout command is implemented in the coin mech **and** enabled by the VMC (0Fh, 01h, bit 2 of Y1 to Y4), while in a controlled manual payout (dispense) mode, the changer **must not** report the coins paid out in response to the **POLL** command. Conversely, if the changer does not support the new command or the VMC does not enable it, the changer **should** report the coins paid out in response to the **POLL** command.

Z1-Z16 = number of controlled manual mode dispensed coins (by coin type)

A single byte is reported for each coin type 0 to 15. For example, Z1 = number of coins of coin type 0 dispensed in a controlled manual payout mode. Any amount above 255 will be reported as 255, i.e. it will reach a maximum limit.

Only coin types supported are required to be reported. Counts for unspent coin types will be assumed to be unchanged.

Note: After power on, changer reset, closing of the machine door, or a change in controlled manual payout status in the changer (changer indicated it was in controlled manual payout mode via CM0510 then changed to any other state) the machine should request the controlled manual coin payout data from the changer using the above command.

Controlled Manual Fill / Payout EVA-DTS Correlation

The controlled manual fill and payout coin information may be used by the vending machine controller as desired (i.e., service mode displays); however, **EVA-DTS** data elements could be used for reporting to a host system. Examples are:

	CA3XX	CA4XX	CA1704	CA1705
Controlled Manual Fill	0F06	n/a	0F06	n/a
VMC Tube Fill	VMC	n/a	VMC	n/a
Controlled Manual Payout	n/a	0F07*	n/a	0F07*
VMC Coin Payout	n/a	VMC	n/a	VMC
Manual Dispense Switches	n/a	0B	n/a	0B

*If extended **0F06** & **0F07** commands are implemented.

If extended **0F06** & **0F07** commands are not implemented in the coin mech or not enabled by the VMC, the coin mech will respond to the **POLL** command with the controlled manual payout coins.

With the above, the **CA3XX** & **CA4XX** fields can continue to be the primary fields for cash audit and the **CA1704** & **CA1705** fields can be used for indicating controlled manually filled / dispensed coins.

Coin Tube Audit Fields

As a reference, below are the agreed **CA17XX** data elements that provide detailed coin tube count information and controlled-manual coin tube insertion / dispense information. These were approved by the **EVA - DTS** Technical Sub Committee on January 27, 1997.

Block Identifier Reference	Data Contents	Characteristic	Length		Element
			Min	Max	
CA17	Coin Type Number (per MDB coin type)	N	01	03	CA1701
	Value of Coin	N	01	08	CA1702
	Number of Coins in Tube	N	01	08	CA1703
	Number of Coins Inserted during Controlled-Manual Fill	N	01	08	CA1704
	Number of Coins Dispensed during Controlled-Manual Payout	N	01	08	CA1705

Definitions:

CA1701 The coin type number as referred to in the MDB Interface Specification. If not an MDB system, the number represents the coin's position in the coin set starting with the lowest value coin accepted. Note if two or more vintage of the same coin is accepted, the oldest one is first.

For example, the Canadian coin types may be:

0 Old Nickel	3 Quarter
1 New Nickel	4 \$1 Dollar
2 Dime	5 \$2 Dollar

CA1702 The cash value of the coin (units base).

For example, the Canadian coin types would be:

Nickel	5	\$1 Dollar	100
Dime	10	\$2 Dollar	200
Quarter	25		

CA1703 The number of coins in the coin tube (or tubes if multiple tubes per coin) that are reported by the coin mech during normal vending operations. Note that this is the "best known tube count" and may be inaccurate if coins were manually added or removed by hand.

CA1704 The number of coins inserted while the changer was in a Controlled manual fill mode. Controlled manual fill indicates that the coins are being inserted under the control of the coin mech or VMC. Coins are not being loaded by hand through the tops of the tubes.

CA1705 The number of coins dispensed while the changer was in a controlled manual payout mode. Controlled manual payout indicates that the coins are being dispensed under the control of the coin mech or VMC. Coins are not being removed by hand by "dumping" the tubes.

<u>VMC Command</u>	<u>Code</u>	<u>Sub-command</u>	<u>VMC Data</u>	<u>Changer Response</u>
EXPANSION COMMAND	0FH	FAH FTL REQ TO RCV	Y1-Y5	Z1 - Zn (immediate or POLLed)

The VMC is requesting to receive data from the changer whose destination address will always be (08H). Note that all FTL Commands / Responses are defined in Section 2.6.

Y1 = Destination address of command (08H)
 Y2 = Source address of command
 Y3 = File ID
 Y4 = Maximum length
 Y5 = Control

Z1 = 1DH which indicates SEND BLOCK
 Z2 = Destination address of data
 Z3 = Block #
 Z4 - Z34 = Data (maximum of 31 bytes)
 or

Z1 = 1CH which indicates RETRY / DENY
 Z2 = Destination address of response
 Z3 = Source address of response (08H)
 Z4 = Retry delay

<u>VMC Command</u>	<u>Code</u>	<u>Sub-command</u>	<u>VMC Data</u>	<u>Changer Response</u>
EXPANSION COMMAND	0FH	FBH FTL RETRY / DENY	Y1-Y3	None

The VMC is retrying, denying, or aborting a data transfer to/from the changer whose destination address will always be (08H). Note that all FTL Commands / Responses are defined in Section 2.6.

Y1 = Destination address of command (08H)
 Y2 = Source address of command
 Y3 = Retry delay

<u>VMC Command</u>	<u>Code</u>	<u>Sub-command</u>	<u>VMC Data</u>	<u>Changer Response</u>
EXPANSION COMMAND	0FH	FCH FTL SEND BLOCK	Y1-Y33	None

The VMC is sending data to the changer whose destination address will always be (08H). Note that all FTL Commands / Responses are defined in Section 2.6.

Y1 = Destination address of command & data (08H)
 Y2 = Block #
 Y3 - Y33 = Data (maximum of 31 bytes)

<u>VMC Command</u>	<u>Code</u>	<u>Sub-command</u>	<u>VMC Data</u>	<u>Changer Response</u>
EXPANSION COMMAND	0FH	FDH FTL OK TO SEND	Y1-Y2	Z1-Z34 (immediate or POLLed)

The VMC is indicating that it is OK for the changer to transfer data. The destination address will always be the changer (08H). Note that all FTL Commands / Responses are defined in Section 2.6.

Y1 = Destination address of command (08H)
 Y2 = Source address of command
 Z1 = 1DH which indicates SEND BLOCK
 Z2 = Destination address of data
 Z3 = Source address of data
 Z4 - Z34 = Data (maximum of 31 bytes)

<u>VMC Command</u>	<u>Code</u>	<u>Sub-command</u>	<u>VMC Data</u>	<u>Changer Response</u>
EXPANSION COMMAND	0FH	FEH FTL REQ TO SEND	Y1-Y5	Z1 (immediate or POLLed)

The VMC is requesting to send data to the changer whose destination address will always be (08H). Note that all FTL Commands / Responses are defined in Section 2.6.

Y1 = Destination address of command (08H)
 Y2 = Source address of command
 Y3 = File ID
 Y4 = Maximum length
 Y5 = Control

Z1 = 1EH which indicates OK TO SEND
 Z2 = Destination address of response
 Z3 = Source address of response (08H)

or

Z1 = 1CH which indicates RETRY / DENY
 Z2 = Destination address of response
 Z3 = Source address of response (08H)
 Z4 = Retry delay

<u>VMC Command</u>	<u>Code</u>	<u>Sub-command</u>	<u>VMC Data</u>	<u>Changer Response</u>
EXPANSION COMMAND	0FH	FFH DIAGNOSTICS	Y1-Yn	Z1-Zn

Y1 - Yn = Device manufacturer specific instruction for implementing various manufacturing or test modes. Y1 - Yn implies that any number of bytes can be used for the VMC data to the peripheral.

Z1 - Zn = Device manufacturer specific responses after receiving manufacturing or test instructions. Z1 - Zn implies that any number of bytes can be used for the changer response data from the peripheral.

5.4 Changer Non-Response Time

The maximum non-response time for the changer is two seconds.

5.5 Changer Power Requirements

The current draw for any changer must fall within the following limits. All measurements are at the minimum VMC Voltage Output.

Idle mode	=	200 mA. (max.) continuous
Coin acceptance	=	1.8 A. (max.) for up to 2 seconds (For coin changers using solenoid based payout mechanisms - typical of 3 tube changers sold in the US market. Vending machines sold into the US market are required to supply this power.)
		1.0A. (max.) for up to 2 seconds (For coin changers using motorized payout mechanisms - typical of 4 tube changers.)
Coin payout	=	3.6 A. (max.) for 100 mS. with 400 mS. idle current between pulses during the coin payout cycle. (For coin changers using solenoid based payout mechanisms - typical of 3 tube changers sold in the US market. Vending machines sold into the US market are required to supply this power.)
		1.8 A. (max.) during the coin payout cycle. (For coin changers using motorized payout mechanisms - typical of 4 tube changers.)

See Note 2 under the DISPENSE (0DH) command for further information on the coin payout cycles.)

Note: If both peripherals are supported, vending machines should be able to provide sufficient power to simultaneously supply the above power requirements for both the coin changer **Coin Acceptance** and bill validator **Bill Transport** as specified in Section 6.5.

5.6 Coin Acceptor/Changer Examples

Event	Exchange
Power up at VMC or JUST RESET received by VMC any other time without reset sequence	Reset sequence Enable sequence
Enter service mode	Disable sequence
Enter sales mode	Enable sequence
Consumer inserts coin	Coin Accept sequence
Credit acceptance is suspended (max. vend price achieved, free vend token accepted, etc.)	Disable sequence
Coins are dispensed	Disable sequence Dispense sequence Enable sequence
Error situation is detected at coin mech.	Error sequence
Manual dispense of coins at coin mech. (only while door is open)	Manual Dispense sequence
Manual filling of coins at coin mech.	Manual Filling sequence

Reset sequence

VMC	Coin Mechanism	Comments
RESET	→ ← ACK	Reset command
POLL	→ ← JUST RESET	Allow peripheral to confirm RESET command
ACK	→	
STATUS	→ ← COIN MECH. CONFIG.	Collect operational parameters
ACK	→	
EXPANSION/ID	→ ← COIN MECH. ID	Collect asset inf. and options list
ACK	→	
EXPANSION/ FEATURE ENABLE	→ ← ACK	Enable compatible options

Error sequence

VMC	Coin Mechanism	Comments
POLL	→ ← STATUS/ERROR	Error sent from coin mech.
ACK	→	

Enable sequence		
VMC		Coin Mechanism
TUBE STATUS	→	
	←	TUBE STATUS
ACK	→	
COIN TYPE ENABLE	→	
	←	ACK

Disable sequence		
VMC		Coin Mechanism
COIN TYPE ENABLE	→	
	←	ACK

Coin Accepted sequence		
VMC		Coin Mechanism
POLL	→	
	←	COINS DEPOSITED
ACK	→	

Coin dispense sequence VMC algorithm		
VMC		Coin Mechanism
TUBE STATUS	→	
	←	TUBE STATUS
ACK	→	
DISPENSE	→	
	←	ACK
POLL	→	
	←	PAY OUT BUSY
ACK	→	
	·	
	·	
	·	
POLL	→	
	←	ACK
TUBE STATUS	→	
	←	TUBE STATUS
ACK	→	
DISPENSE	→	
	←	ACK

Coin dispense sequence		Alternative pay out method	
VMC		Coin Mechanism	Comments
EXPANSION/ ALT. PAY OUT	→		Report value to be paid out
	←	ACK	
EXPANSION/ ALT. PAY OUT VALUE POLL	→		Request paid value
	←	VALUE PAID	“value” paid since last VALUE POLL (may be 00)
ACK	→		
	.		
	.		
	.		
EXPANSION/ ALT. PAY OUT VALUE POLL	→		Request paid value
	←	ACK	Pay out is complete
EXPANSION/ ALT. PAY OUT STATUS	→		Request pay out status
	←	COINS PAID	Itemization of coins paid
ACK	→		
TUBE STATUS	→		Update current tube status counters
	←	TUBE STATUS	
ACK	→		
Manual dispense sequence			
VMC		Coin Mechanism	Comments
POLL	→		
	←	COINS DISPENSED MANUALLY	Number, type, and tube levels for coin just manually dispensed
ACK	→		
TUBE STATUS	→		Update current tube status counters
	←	TUBE STATUS	
ACK	→		

Manual fill VMC	sequence	Coin Mechanism	Comments
EXPANSION COMMAND (Send controlled manual fill report)	→		
	←	NUMBER OF CONTROLLED MANUAL MODE FILLED COINS	Number for coins manually filled, only possible, if the changer supports extended diagnostics and/or controlled manual filled and payout reports (at least b2 set in the options bytes)
ACK	→		
TUBE STATUS	→		Update current tube status counters
	←	TUBE STATUS	
ACK	→		

Section 6

Bill Validator / Recycler

VMC/Peripheral Communication Specifications

6.1 Introduction

This section defines the communication bytes sent and received between a Bill Validator / Recycler and the VMC. In the text below, all references to “bill validator” includes the optional bill recycler except where expressly noted.

As defined in Section 2.3, the bill validator’s address is 00110xxxB (30H).

Unless stated otherwise, all information is assumed to be in a binary format.

There are currently two levels of support defined for the bill validator interface, Level 1 and Level 2. The level of bill validator operation is sent to the VMC in the response to the STATUS command (defined later in this section). The following paragraphs will define how a VMC should differentiate between each level.

Level 1 Bill Validators

Level 1 bill validators support all standard functions, but do not support any optional features.

Level 2 Bill Validators

Level 2 bill validators support all standard functions plus various optional features as defined in Section 6.3 under the Expansion command 37-02H. Based on the optional feature information the VMC will determine the appropriate operating mode (in other words, modes that both the bill validator and the VMC can support), enable any appropriate features by sending an appropriate feature enable command back to the bill validator, and enter the proper operating mode. This technique allows all VMCs and peripherals to accommodate existing feature capabilities and provides a means for upgrading Level 2 equipment.

Level 2 bill validator / recyclers will also support all standard functions plus the optional recycling feature as defined in Section 6.3 under the Expansion command 37-02H. Additional commands 37-03H through 37-09H allow control of the bill recycler. **The unit should NOT respond to any Recycler/Dispenser commands or send any Recycler POLL responses unless the Bill Recycler expansion commands are enabled by the VMC (b1=1) and the VMC has request the DISPENSER SETUP (37 03) command.**

6.2 VMC Commands

<u>Command</u>	<u>Hex Code</u>	<u>Description</u>
RESET	30H	Command for bill validator to self-reset.
SETUP *	31H	Request for bill validator setup information.
SECURITY	32H	Sets Validator Security Mode
POLL	33H	Request for Bill Validator activity Status.
BILL TYPE	34H	Indicates Bill Type enable or disable. Command is followed by set-up data. See command format.
ESCROW	35H	Sent by VMC to indicate action for a bill in escrow.
STACKER	36H	Indicates stacker full and the number of bills.
EXPANSION COMMAND	37H	Command to allow addition of features and future enhancements. Level 1 and above bill validators must support this command.

NOTE: The expansion command is always followed by a sub-command.

* In Version 1.0 & 2.0, **SETUP** was called **STATUS**.

6.3 VMC Command Format

<u>VMC Command</u>	<u>Code</u>	<u>VMC Data</u>
RESET	30H	No data bytes

This command is the vehicle that the VMC should use to tell the validator that it should return to its default operating mode. It should reject any bills in the validation process, return any bills in the escrow position, and disable all other activity until otherwise instructed by the VMC.

The following initialization sequence is recommended for all new VMCs designed after July, 2000. It should be used after “power up”, after issuing the RESET command, after issuing the Bus Reset (pulling the transmit line “active” for a minimum of 100 mS), or anytime a POLL command results in a “JUST RESET” response (i.e., peripheral self resets).

POLL – 33h

To obtain “JUST RESET” response

SETUP – 31h

To obtain bill validator level and configuration information

EXPANSION IDENTIFICATION – 37 00h (Level 01+)

To obtain additional bill validator information

EXPANSION IDENTIFICATION w/ OPTION BITS – 37 02h (Level 02+ only)

To obtain additional bill validator information and options

EXPANSION FEATURE ENABLE – 37 01h (Level 02+ only)

To enable desired options

STACKER – 36h

To obtain stacker status and number of bills

BILL TYPE – 34h

To enable desired bill acceptance and desired bill escrow capability

<u>VMC Command</u>	<u>Code</u>	<u>Validator Response Data</u>
SETUP	31H	27 bytes: Z1 - Z27

Z1 = Bill Validator Feature Level - 1 byte
Indicates current feature level of the bill validator. Currently defined levels are:

Level 1 - does not support option bits (Z1 = 01h)

Level 2 - supports option bits (Z1 = 02h)

Z2 - Z3 = Country / Currency Code - 2 bytes
The packed BCD country / currency code of the bill validator can be sent in two different forms depending on the value of the left most BCD digit.

If the left most digit is a 0, the International Telephone Code is used to indicate the country that the validator is set-up for. For example, the USA code is 00 01H (Z2 = 00 and Z3 = 01).

If the left most digit is a 1, the latest version of the ISO 4217 numeric currency code is used (see Appendix A1). For example, the code for the US dollar is 18 40H (Z2 = 18 and Z3 = 40) and for the Euro is 19 78 (Z2 = 19 and Z3 = 78).

All new designs after July, 2000 must use the ISO 4217 numeric currency codes as listed in Appendix A1.

Z4 - Z5 = Bill Scaling Factor - 2 bytes
All accepted bill values must be evenly divisible by this number. For example, this could be set to 0064H for the USA.

Z6 = Decimal Places - 1 byte
Indicates the number of decimal places on a credit display. For example, this could be set to 02H for the USA.

Z7 - Z8 = Stacker Capacity - 2 bytes
Indicates the number of bills that the stacker will hold. For example, 400 bill capacity = 0190H.

Z9 - Z10 = Bill Security Levels - 2 bytes
Indicates the security level for bill types 0 to 15. Since not all validators support multiple security levels, validators that do not have this feature must report a "high" security level.

Z11 = Escrow/No Escrow - 1 byte
 Indicates the escrow capability of the bill validator. If Z11 = 00H, the bill validator does not have escrow capability. If Z11 = FFH, the bill validator has escrow capability.

Z12 - Z27 = Bill Type Credit - 16 bytes
 Indicates the value of the bill types 0 to 15. Values must be sent in ascending order. This number is the bill's monetary value divided by the bill scaling factor. Unused bill types are sent as 00H. Unsent bill types are assumed to be zero. FFH bills are assumed to be vend tokens.

<u>VMC Command</u>	<u>Code</u>	<u>VMC Data</u>
SECURITY	32H	2 Bytes: Y1 - Y2

Y1 - Y2 = Bill Type(s) - 2 bytes

b15 b14 b13 b12 b11 b10 b9 b8 | b7 b6 b5 b4 b3 b2 b1 b0
 Y1 Y2

A bit is set to indicate the type of bill(s) which are set to a "high" security level. Note that validators that do not support dual security levels should report a "high" security level in the response bytes Z9-Z10 to the STATUS (31H) command.

<u>VMC Command</u>	<u>Code</u>	<u>Validator Response Data</u>
--------------------	-------------	--------------------------------

POLL	33H	16 bytes: Z1 - Z16
------	-----	--------------------

Z1 - Z16 = Bill Validator Activity - 16 bytes

Indicates the validator activity, for example, the type and number of bills accepted, stacker position, recycler actions, or error conditions. If there is nothing to report, the validator should send only an ACK. Otherwise, the only valid responses are:

Bills Accepted:

Indicates the type and number of bills accepted, validator stacker status, or recycler status. The first four Bill Routing responses (yyy = 000 to 011) should be used to add or subtract credit. The last four Bill Routing responses (yyy = 100 to 111) are for audit information (EVS-DTS fields).

Z1
(1yyyxxxx)

yyy	=	Bill Routing;	000: BILL STACKED
			001: ESCROW POSITION ²
			010: BILL RETURNED
			011: BILL TO RECYCLER ¹
			100: DISABLED BILL REJECTED
			101: BILL TO RECYCLER – MANUAL FILL ^{1,3}
			110: MANUAL DISPENSE ¹
			111: TRANSFERRED FROM RECYCLER TO CASHBOX ¹

xxxx = Bill Type (0 to 15)

Notes:

1. These responses can only be sent if the Bill Recycler expansion commands are enabled by the VMC (b1=1) and the VMC has request the RECYCLER ENABLE (37 04) command.
2. A bill should not be considered secure unless the VMC gets the Bill Stacked or Bill To Recycler response.
3. If during manual fill mode a bill is put into the cashbox the validator/recycler must report a "BILL TO RECYCLER – MANUAL FILL" and "TRANSFERRED FROM RECYCLER TO CASHBOX".

(**Status** codes continued on next two pages)

Status:**Bill Validator (Only)**

(00000001) =	Defective Motor ³ - One of the motors has failed to perform its expected assignment.
(00000010) =	Sensor Problem ³ - One of the sensors has failed to provide its response.
(00000011) =	Validator Busy ² - The validator is busy and can not answer a detailed command right now.
(00000100) =	ROM Checksum Error ³ - The validators internal checksum does not match the calculated checksum.
(00000101) =	Validator Jammed ³ - A bill(s) has jammed in the acceptance path.
(00000110) =	Validator was reset ¹ - The validator has been reset since the last POLL.
(00000111) =	Bill Removed ¹ - A bill in the escrow position has been removed by an unknown means. A BILL RETURNED message should also be sent.
(00001000) =	Cash Box out of position ³ - The validator has detected the cash box to be open or removed.
(00001001) =	Validator Disabled ² - The validator has been disabled, by the VMC or because of internal conditions.
(00001010) =	Invalid Escrow request ¹ - An ESCROW command was requested for a bill not in the escrow position.
(00001011) =	Bill Rejected ¹ - A bill was detected, but rejected because it could not be identified.
(00001100) =	Possible Credited Bill Removal ¹ - There has been an attempt to remove a credited (stacked) bill.

Note:

- validators must have a means to disable this code due to potential older VMC issues.
- virtually all VMCs designed prior to this code's introduction (10/16/02) will not support it.
- It is a vending machine system issue as to what is done when this code is received.

(010xxxx) = Number of attempts to input a bill while validator is disabled.¹

NOTE: The validator may send several of one type activity* up to 16 bytes total.

- 1 Sent once each occurrence.
- 2 Sent once each POLL
- 3 Sent once each occurrence. The validator is then disabled until the condition is removed. Validator will respond with validator disabled until repaired or replaced.

* Type activity is defined as Bills Accepted and Status. All may be combined in a response to a POLL command providing the total number of bytes does not exceed 16.

Status:	Bill Recycler (Only)
(00100001) =	Escrow request ¹ - An escrow lever activation has been detected. If a button is present and activated.
(00100010) =	Dispenser Payout Busy ² - The dispenser is busy activating payout devices.
(00100011) =	Dispenser Busy ² - The dispenser is busy and can not answer a detailed command right now.
(00100100) =	Defective Dispenser Sensor ⁴ - The dispenser has detected one of the dispenser sensors behaving abnormally.
(00100101) =	Not Used
(00100110) =	Dispenser did not start / motor problem ⁴ .
(00100111) =	Dispenser Jam ⁴ - A dispenser payout attempt has resulted in jammed condition.
(00101000) =	ROM checksum error ⁴ - The dispensers internal checksum does not match the calculated checksum. (If separate from validator microprocessor.)
(00101001) =	Dispenser disabled – dispenser disabled because of error or bill in escrow position.
(00101010) =	Bill waiting ^{2,5} – waiting for customer removal
(00101011) =	Not Used
(00101100) =	Not Used
(00101101) =	Not Used
(00101110) =	Not Used
(00101111) =	Filled key pressed ¹ – The VMC should request a new DISPENSER STATUS.

NOTES: The dispenser may send several of one type activity, up to 16 bytes total include both bill validator and bill recycler. This will permit zeroing counters such as inventory and status. These responses can only be sent if the Bill Recycler expansion commands are enabled by the VMC (b1=1) and the VMC has request the DISPENSER SETUP (37 03) command.

- 1 Sent once each occurrence.
- 2 Sent once each POLL
- 3 Not used
- 4 Sent once each occurrence. The dispenser is then internally disabled until the condition is removed. If the validator can still be used. Dispenser will respond with dispenser disabled until the condition is removed. If the failure affects both the validator and dispenser it will respond with both validator disabled and dispenser disabled until the condition is removed.
- 5 VMC must monitor this flag along with the PAYOUT VALUE POLL command (alternate Poll (33H) and Payout Status (37H-09H) commands) to determine when the recycler dispense operations are complete, or if a bill is in the inlet waiting for a customer to remove it.

File Transport Layer POLLED responses:

Note that all FTL responses are defined in Section 2.6. For the bill validator, the source address will always be the validator (30H) as defined in Section 2.3.

Z1

1B	REQ TO RCV	<p>The bill validator is requesting to receive data from a device or VMC.</p> <p>Z2 = Destination address of response Z3 = Source address of response (30H) Z4 = File ID Z5 = Maximum length Z6 = Control</p>
1C	RETRY/DENY	<p>The bill validator is requesting a device or VMC to retry or deny the last FTL command.</p> <p>Z2 = Destination address of response Z3 = Source address of response (30H) Z4 = Retry delay</p>
1D	SEND BLOCK	<p>The bill validator is sending a block of data (maximum of 31 bytes) to a device or VMC.</p> <p>Z2 = Destination address of data Z3 = Block # Z4-Z34 = Data (maximum of 31 bytes)</p>
1E	OK TO SEND	<p>The bill validator is indicating that it is OK for the device or VMC to send it data.</p> <p>Z2 = Destination address of response Z3 = Source address of response (30H)</p>
1F	REQ TO SEND	<p>The bill validator is requesting to send data to a device or VMC.</p> <p>Z2 = Destination address of response Z3 = Source address of response (30H) Z4 = File ID Z5 = Maximum length Z6 = Control</p>

<u>VMC Command</u>	<u>Code</u>	<u>VMC Data</u>
BILL TYPE	34H	4 bytes: Y1 - Y4

Y1 - Y2 = Bill Enable - 2 bytes

Indicates what type of bills are accepted.

b15 b14 b13 b12 b11 b10 b9 b8 | b7 b6 b5 b4 b3 b2 b1 b0
 Y1 Y2

Bill types are 0 to 15. A bit is set to indicate acceptance of bill type.

NOTE: Sending 0000H disables the bill validator.

Y3 - Y4 = Bill Escrow Enable:

b15 b14 b13 b12 b11 b10 b9 b8 | b7 b6 b5 b4 b3 b2 b1 b0
 Y3 Y4

Bill types are 0 to 15. A bit is set to indicate enable of escrow for a bill type.

NOTE: On power-up or reset all bill acceptance and escrow are disabled.

<u>VMC Command</u>	<u>Code</u>	<u>VMC Data</u>
ESCROW	35H	1 byte: Y1

ESCROW 35H 1 byte: Y1

Y1 = Escrow status - 1 byte

If Y1 = 0;	Return bill in the escrow position.
If Y1 = xxxxxx1;	Stack the bill ("x" indicates don't care)

NOTE: After an ESCROW command the bill validator should respond to a POLL command with the BILL STACKED, BILL RETURNED, INVALID ESCROW or BILL TO RECYCLER message within 30 seconds. If a bill becomes jammed in a position where the customer may be able to retrieve it, the bill validator should send a BILL RETURNED message.

It is the responsibility of the VMC to stack or return any bills in escrow PRIOR to issuing the DISPENSE BILL or DISPENSE VALUE message. Leaving a bill in escrow position may lead to failed recycler operations.

<u>VMC Command</u>	<u>Code</u>	<u>Validator Response Data</u>
STACKER	36H	2 bytes: Z1 - Z2

Indicates stacker full condition and the number of bills in the stacker.

Z1 Z2

(Fxxxxxxx) (xxxxxxx)

F = 1 if stacker is full, 0 if not.

xxxxxxxxxxxxxx = The number of bills in the stacker.

LEVEL ONE and TWO+ CAPABILITIES - EXPANSION COMMAND

In order to allow existing VMCs to operate with original Level 1 or new Level 2 bill validators, a separate identification sub-command has been introduced to handle the additional 4 bytes of Option Bit information.

The original sub-command 00H is used for obtaining Z1 to Z29 identification information from bill validators. This information includes the model number, serial number, software version, etc, but **not the option bits**. Note that if a Level 2+ bill validator is sent the 00H sub-command, it must **not** report the Z30 to Z33 option bytes.

Sub-command 01H is used for Level 2+ bill validators to enable option bits reported in the expansion command 02H sub-command below.

The new sub-command 02H is used for obtaining Z1 to Z33 identification information from Level 2+ bill validators. This information includes the model number, serial number, software version, etc, and the **option bits (Z30-Z33)**.

<u>VMC Command</u>	<u>Code</u>	<u>Sub-Command</u>	<u>Validator Response Data</u>
EXPANSION COMMAND	37H	00H	29 bytes: Z1 - Z29
		LEVEL 1 IDENTIFICATION WITHOUT OPTION BITS	

Z1 - Z3 = Manufacturer Code - 3 bytes
 Identification code for the equipment supplier. Sent as ASCII characters. Currently defined codes are listed in the **EVA** document entitled "**European Vending Association Data Transfer Standard**" (**EVA-DTS**), the Audit Data Lists section, sub-section 2, "Manufacturer Codes".

- Z4 - Z15 = Serial Number - 12 bytes
Factory assigned serial number. All bytes must be sent as ASCII characters, zeros (30H) and blanks (20H) are acceptable.
- Z16 - Z27 = Model #/Tuning Revision - 12 bytes
Manufacturer assigned model number. All bytes must be sent as ASCII characters, zeros (30H) and blanks (20H) are acceptable.
- Z28 - Z29 = Software Version - 2 bytes
Current software version. Must be sent in packed BCD.

<u>VMC Command</u>	<u>Code</u>	<u>Sub-Command</u>	<u>VMC Data</u>
EXPANSION	37H	01H	4 bytes: Y1 - Y4
COMMAND	LEVEL 2+ FEATURE ENABLE		

This command is used to enable each of the Level 2+ optional features defined in the Level 2+ Identification response bytes Z30-Z33 below. To enable a feature a bit is set to one. **All optional features are disabled after reset.**

<u>VMC Command</u>	<u>Code</u>	<u>Sub-Command</u>	<u>Validator Response Data</u>
EXPANSION	37H	02H	33 bytes: Z1 – Z33
COMMAND	LEVEL 2+ IDENTIFICATION WITH OPTION BITS		

- Z1 - Z3 = Manufacturer Code - 3 bytes
Identification code for the equipment supplier. Sent as ASCII characters. Currently defined codes are listed in the **EVA** document entitled "**European Vending Association Data Transfer Standard**" (**EVA-DTS**), the Audit Data Lists section, sub-section 2, "Manufacturer Codes".
- Z4 - Z15 = Serial Number - 12 bytes
Factory assigned serial number. All bytes must be sent as ASCII characters, zeros (30H) and blanks (20H) are acceptable.
- Z16 - Z27 = Model #/Tuning Revision - 12 bytes
Manufacturer assigned model number. All bytes must be sent as ASCII characters, zeros (30H) and blanks (20H) are acceptable.
- Z28 - Z29 = Software Version - 2 bytes
Current software version. Must be sent in packed BCD.
- Z30 - Z33 = Optional Features - 4 bytes

Each of the 32 bits indicate an optional features availability. If the bit is set the feature is available. Bits should be sent in descending order, i.e. bit 31 is sent first and bit 0 is sent last. Currently defined options are:

- b0 - File Transport Layer (FTL) supported as defined in Section 2.6.
- b1 - Bill Recycling supported
- b2 - b31 Available for future use

<u>VMC Command</u>	<u>Code</u>	<u>Sub-Command</u>	<u>Recycler Response Data</u>
EXPANSION COMMAND (Bill Recycler)	37H	03H RECYCLER SETUP	2 bytes: Z1 – Z2

Z1 – Z2 = Bill Type Routing - 2 bytes

Indicates what bill types can be routed to the Recycler dispenser.

b15 b14 b13 b12 b11 b10 b9 b8 | b7 b6 b5 b4 b3 b2 b1 b0
Z1 Z2

Bit is set to indicate a bill type can be routed to the dispenser. Valid bill types are 0 to 15.

<u>VMC Command</u>	<u>Code</u>	<u>Sub-Command</u>	<u>VMC Data</u>
EXPANSION COMMAND (Bill Recycler)	37H	04H RECYCLER ENABLE	19 bytes: Y1 – Y18

Y1 - Y2 = Manual Dispense Enable - 2 bytes

b15 b14 b13 b12 b11 b10 b9 b8 | b7 b6 b5 b4 b3 b2 b1 b0
Y1 Y2

A bit is set to indicate manual dispense enable. For example, bit 2 is set to enable manual dispensing of bill type 2. This command enables/disables manual dispensing using optional inventory switches. All manual dispensing switches are automatically disabled upon reset.

Y3 – Y18 = Bills Recycler Enabled - 16 bytes

Indicates which bills will be routed to the Recycler:

- 0 = Bill type disable
- 1 = Only High quality bills are used
- 2 = Only High and Medium quality bills are used
- 3 = Use all possible bills (this is the recommended setting – the recycler will use its internal setting to determine what bill are put into the recycler)

Note: Y3 = Bill Type 0 while Y18 = Bill type 15

<u>VMC Command</u>	<u>Code</u>	<u>Sub-Command</u>	<u>Recycler Response Data</u>
EXPANSION COMMAND (Bill Recycler)	37H	05H	34 bytes: Z1 – Z34
	BILL DISPENSE STATUS		

Z1 - Z2 = Dispenser Full Status - 2 bytes

Indicates status of dispenser for bill types 0 to 15.

b15 b14 b13 b12 b11 b10 b9 b8 | b7 b6 b5 b4 b3 b2 b1 b0
 Z1 | Z2

A bit is set to indicate a full dispenser. For example, bit 7 = set would indicate the dispenser for bill type 7 is full.

Z3 – Z34 = Bill Count - 32 bytes

Indicates the greatest number of bills that the dispenser “knows” definitely are present in the dispenser. A word (2 bytes) position in the 32 byte string indicates the number of bills in a dispenser for a particular bill type. For example, the first 2 bytes sent indicate the number of bills in a dispenser for dispenser type 0. Unsent bytes are assumed to be zero. For dispenser counts greater than 65535, counts should remain at 65535.

NOTE: If a dispenser can detect a dispenser jam, defective dispenser sensor, or other malfunction, it will indicate the dispenser is "bad" by sending a dispenser full status and a count of zero for the malfunctioning bill type.

<u>VMC Command</u>	<u>Code</u>	<u>Sub-Command</u>	<u>VMC Data</u>
EXPANSION COMMAND (Bill Recycler)	37H	06H DISPENSE BILL	3 bytes: Y1 – Y3

Y1 = Bill type to be dispensed

b7 b6 b5 b4 b3 b2 b1 b0

Bits b7, b6, b5, b4 = 0.

Bits b3, b2, b1, b0 indicate bill type to be dispensed.

Valid codes are 0H to FH to indicate bill types 0 to 15.

Y2 - Y3 = Number of bills to be dispensed of bill type defined in Y1

There is no defined limit on how long the actual dispense takes since the command allows for up to 65535 bills to be paid out. The payout cycle begins when the dispenser ACKs the VMC's DISPENSE BILL command. The VMC should wait at least 30 seconds per bill. If the VMC wants to stop the dispensing of bills it can send the CANCEL command.

The VMC must send the PAYOUT VALUE POLL message during the dispense operation to monitor payout, decrement the vendor display, and determine when the operation is complete. The VMC must also send the POLL command to determine if any bills are moved from the recycler to the cashbox or a bill is in the inlet waiting for a customer to remove it. After the dispense operation is complete the PAYOUT STATUS command must be sent to determine what bills were dispensed.

Only one payout operation (DISPENSE BILL or DISPENSE VALUE) may be active at one time. The bill validator is not expected to buffer additional dispense or payout commands while the current command is active. In addition, the VMC should not issue the DISPENSE BILL command if a bill is waiting to for customer removal or if any bills are in the escrow position.

<u>VMC Command</u>	<u>Code</u>	<u>Sub-Command</u>	<u>VMC Data</u>
EXPANSION COMMAND (Bill Recycler)	37H	07H DISPENSE VALUE	2 bytes: Y1, Y2

Y1 – Y2 = Value of bills to be paid out.

Y1 and Y2 are defined as the total value of bills to be paid out. This value is expressed as the actual credit value divided by the bill scaling factor. For example, in a USA system using a scaling factor of 100 (64H), if the change to be paid out is \$15.00, then Y1 will equal 15. The bill dispenser will determine which actual denominations of bills will be paid out. In the

\$15.00 example, the bills may be 3 \$5 bills; or, 1 \$10 bill & 1 \$5 bill; or, 2 \$5 bills & 5 \$1 bills, etc. .

There is no defined limit on how long the actual dispense takes. The payout cycle begins when the dispenser ACKs the VMC's DISPENSE VALUE command. The VMC should wait at least 30 seconds per bill. If the VMC wants to stop the dispensing of bills it can send the CANCEL command.

The VMC must send the PAYOUT VALUE POLL message during the dispense operation to monitor payout, decrement the vendor display, and determine when the operation is complete. The VMC must also send the POLL command to determine if any bills are moved from the recycler to the cashbox or a bill is in the inlet waiting for a customer to remove it. After the dispense operation is complete the PAYOUT STATUS command must be sent to determine what bills were dispensed.

Only one payout operation (DISPENSE BILL or DISPENSE VALUE) may be active at one time. The bill validator is not expected to buffer additional dispense or payout commands while the current command is active. In addition, the VMC should not issue the DISPENSE BILL command if a bill is waiting to for customer removal or if any bills are in the escrow position.

<u>VMC Command</u>	<u>Code</u>	<u>Sub-Command</u>	<u>Recycler Response Data</u>
EXPANSION COMMAND (Bill Recycler)	37H	08H PAYOUT STATUS	32 bytes: Z1 – Z32

Z1 – Z32 = Number of each bill type paid out (2 bytes per bill type).

This is the dispenser's response to the last VMC DISPENSE BILL (37-06) or DISPENSE VALUE (37-07) command. Bytes are sent in ascending order of bill types. A byte's position in the string indicates the bill type. That is, bytes one and two are the number of bills for bill type 1, bytes three and four are the number of bills for bill type two, and so on. Unsent bytes above the bill types dispensed are assumed to be zero.

The dispenser clears payout data after an ACK response from the VMC.

The VMC should compare the value of the bills paid out to the VMC DISPENSE BILL (37-06) or DISPENSE VALUE (37-07) command.

NOTES: 1) If the dispenser's payout is busy it will respond to the PAYOUT STATUS command with an ACK only.

- 2) If no bills have been paid out, at least one zero valued data byte must be sent.

<u>VMC Command</u>	<u>Code</u>	<u>Sub-Command</u>	<u>Recycler Response Data</u>
EXPANSION COMMAND (Bill Recycler)	37H	09H PAYOUT VALUE POLL	2 bytes: Z1 – Z2

Z1 – Z2 = Dispenser Payout Activity - 2 bytes

An interval value (scaled) which indicates the amount of paid out bills since the previous PAYOUT VALUE POLL (or between the initial DISPENSE VALUE command and the first PAYOUT VALUE POLL).

A 00H response indicates no bills were paid out since the previous PAYOUT VALUE POLL (or the initial DISPENSE VALUE command).

An ACK only indicates that the bill payout is finished. This must be followed by the PAYOUT STATUS command to obtain the complete payout data.

NOTE: The initial intent of this command is to determine the amount of bills paid out so that the credit display can be decremented as bills are dispensed.

<u>VMC Command</u>	<u>Code</u>	<u>Sub-Command</u>	<u>Recycler Response Data</u>
EXPANSION COMMAND (Bill Recycler)	37H	0AH PAYOUT CANCEL	None

NOTE: The Recycler should stop the active payout function within 30 seconds. The VMC must continue to send the PAYOUT VALUE POLL until it receives an ACK indicating the payout is complete. The VMC must then send the PAYOUT STATUS to determine what bill were dispensed.

The VMC MUST issue this command if it implements any type of payout timeout.

<u>VMC Command</u>	<u>Code</u>	<u>Sub-command</u>	<u>VMC Data</u>	<u>Validator Response</u>
EXPANSION COMMAND	37H	FAH FTL REQ TO RCV	Y1-Y5	Z1 (immediate or POLLed)

The VMC is requesting to receive data from the bill validator whose destination address will always be (30H). Note that all FTL Commands / Responses are defined in Section 2.6.

Y1 = Destination address of command (30H)
 Y2 = Source address of command
 Y3 = File ID
 Y4 = Maximum length
 Y5 = Control

Z1 = 1DH which indicates SEND BLOCK
 Z2 = Destination address of data
 Z3 = Block #
 Z4 - Z34 = Data (maximum of 31 bytes)
 or

Z1 = 1CH which indicates RETRY / DENY
 Z2 = Destination address of response
 Z3 = Source address of response (30H)
 Z4 = Retry delay

<u>VMC Command</u>	<u>Code</u>	<u>Sub-command</u>	<u>VMC Data</u>	<u>Validator Response</u>
EXPANSION COMMAND	37H	FBH FTL RETRY / DENY	Y1-Y3	None

The VMC is retrying, denying, or aborting a data transfer to/from the bill validator whose destination address will always be (30H). Note that all FTL Commands / Responses are defined in Section 2.6.

Y1 = Destination address of command (30H)
 Y2 = Source address of command
 Y3 = Retry delay

<u>VMC Command</u>	<u>Code</u>	<u>Sub-command</u>	<u>VMC Data</u>	<u>Validator Response</u>
EXPANSION COMMAND	37H	FCH FTL SEND BLOCK	Y1-Y33	None

The VMC is sending data to the bill validator whose destination address will always be (30H). Note that all FTL Commands / Responses are defined in Section 2.6.

- Y1 = Destination address of command & data (30H)
- Y2 = Block #
- Y3 - Y33 = Data (maximum of 31 bytes)

<u>VMC Command</u>	<u>Code</u>	<u>Sub-command</u>	<u>VMC Data</u>	<u>Validator Response</u>
EXPANSION	37H	FDH	Y1-Y2	Z1-Z34 (immediate or
COMMAND		FTL OK TO SEND		POLLed)

The VMC is indicating that it is OK for the bill validator to transfer data. The destination address will always be the validator (30H). Note that all FTL Commands / Responses are defined in Section 2.6.

- Y1 = Destination address of command (30H)
- Y2 = Source address of command

- Z1 = 1DH which indicates SEND BLOCK
- Z2 = Destination address of data
- Z3 = Source address of data
- Z4 - Z34 = Data (maximum of 31 bytes)

<u>VMC Command</u>	<u>Code</u>	<u>Sub-command</u>	<u>VMC Data</u>	<u>Validator Response</u>
EXPANSION	37H	FEH	Y1-Y5	Z1 (immediate or
COMMAND		FTL REQ TO SEND		POLLed)

The VMC is requesting to send data to the bill validator whose destination address will always be (30H). Note that all FTL Commands / Responses are defined in Section 2.6.

- Y1 = Destination address of command (30H)
- Y2 = Source address of command
- Y3 = File ID
- Y4 = Maximum length
- Y5 = Control

- Z1 = 1EH which indicates OK TO SEND
- Z2 = Destination address of response
- Z3 = Source address of response (30H)
or
- Z1 = 1CH which indicates RETRY / DENY
- Z2 = Destination address of response
- Z3 = Source address of response (30H)
- Z4 = Retry delay

<u>VMC Command</u>	<u>Code Sub-Command</u>	<u>VMC Data</u>	<u>Val Response</u>
EXPANSION COMMAND	37H FFH DIAGNOSTICS	Y1-Yn	Z1 - Zn

Y1 - Yn = Device manufacturer specific instruction for implementing various manufacturing or test modes. Y1 - Yn implies that any number of bytes can be used for the VMC data to the peripheral.

Z1 - Zn = Device manufacturer specific responses after receiving manufacturing or test instructions. Z1 - Zn implies that any number of bytes can be used for the bill validator response data from the peripheral.

6.4 Bill Validator / Recycler Non-Response Time

The maximum non-response time for the bill validator is five seconds.

6.5 Bill Validator / Recycler Power Requirements

The current draw for any bill validator must fall within the following limits. All measurements are at the minimum VMC Voltage Output.

- Idle mode = 200 mA. (avg.) continuous
- Bill transport = 2.5 A. (max.) up to 30 seconds
- Bill dispense = 2.5 A. (max.) up to 30 seconds per bill

Note: If both peripherals are supported, vending machines should be able to provide sufficient power to simultaneously supply the above power requirements for both the bill validator **Bill Transport** and coin mechanism **Coin Acceptance** as specified in Section 5.5.

6.6 Bill Validator Examples

Event	Exchange
Power up at VMC or JUST RESET received by VMC any other time without reset sequence	Reset sequence Enable sequence
Mode switch activated, enter service mode	Disable sequence
Mode switch activated, enter sales mode	Enable sequence
Consumer inserts bill	Accept sequence
Bill in escrow position is stacked	Stack sequence
Bill in escrow position is returned	Return sequence
Error situation is detected at validator	Error sequence
Error situation is detected at validator/stacker	Stack control sequence
Bill dispense	Bill Dispense request
Value dispense	Value Payout request
Bill dispense with bill in escrow	Bill Dispense w/ Bill in Escrow
Value dispense with bill in escrow	Value Payout w/ Bill in escrow
Cancel dispense	Value Payout Cancelled
Multiple dispense	Multiple Dispense (or Payout) Requests

Reset sequence		
VMC	Bill Validator	Comments
RESET	→	Reset command
	← ACK	
POLL	→	Allow peripheral to confirm RESET command
	← JUST RESET	
ACK	→	
STATUS	→	Collect operational parameters
	← VALIDATOR CONFIG.	
ACK	→	
SECURITY	→	Update bill security Levels (Optional)
	← ACK	
EXPANSION/ID	→	Collect asset info.
	← VALIDATOR ID	
ACK	→	
FEATURE ENABLE	→	
	← ACK	
RECYCLER SETUP	→	If a recycler is available
	← BILL ROUTING	
ACK	→	
RECYCLER ENABLE	→	If a recycler is available
	← ACK	

Enable sequence		
Controller	Bill Validator	Comments
STACKER	→	Update stacker count
ACK	← BILL COUNT	
BILL TYPE ENABLE	→	Enable appropriate bill types
ACK	←	

Disable sequence		
Controller	Bill Validator	Comments
BILL TYPE ENABLE	→	Disable all bill types
ACK	←	

Error sequence		
Controller	Bill Validator	Comments
POLL	→	Error sent from Bill validator
ACK	← STATUS/ERROR	

Accept sequence		Bill stacked	Comments
Controller	Bill Validator		
POLL	→	BILL ACCEPTED	Bill type and routing (ESCROW POSITION)
ACK	←		
	→		
	←		
	→		
	←		
ESCROW	→	ACK	Send bill to stacker
ACK	←		
	→	BILL ACCEPTED	Bill type and routing (BILL STACKED)
	←		
POLL	→		
ACK	←		

Accept sequence		Bill returned	Comments
Controller	Bill Validator		
POLL	→	BILL ACCEPTED	Bill type and routing (ESCROW POSITION)
ACK	←		
	→		
	←		
	→		
	←		

Multi-Drop Bus / Internal Communication Protocol

ESCROW	→		Return bill to consumer
	←	ACK	
	.		
	.		
POLL	→		
	←	BILL ACCEPTED	Bill type and routing (BILL RETURNED)
ACK	→		
Check stacker after Accept sequence		Bill stacked	
Controller		Bill Validator	Comments
POLL	→		
	←	BILL ACCEPTED	Bill type and routing (BILL STACKED)
ACK	→		
	.		
	.		
STACKER	→		Update stacker count
	←	BILL COUNT	
ACK	→		
BILL TYPE ENABLE	←		Disable all bill types, if stacker is full
	→	ACK	

Dispense Sequence			
Controller		Bill Validator	Comments
POLL	→		
	←	BILL WAITING	Inlet blocked, pending customer
ACK	→		
POLL	→		
	←	ACK	Inlet unblocked
DISPENSE BILL	→		Dispense # of bills
	←	ACK	
PAYOUT VALUE POLL	→		
	←	VALUE PAID	
ACK	→		
POLL	→		
	←	ACK	Inlet blocked, bill transferred from the recycler to the cashbox, or error code
	.		
	.		
	.		Repeat last 2 commands
PAYOUT VALUE POLL	→		
	←	ACK	Payout Complete
PAYOUT STATUS	→		

ACK	← →	BILLS PAID	Count of each bill type
BILL DISPENSE STATUS	→	DISPENSER STATUS	Update Bill counts
ACK	← →		

Value Payout			
Controller		Bill Validator	Comments
POLL	→	BILL WAITING	Inlet blocked, pending customer
ACK	←		
POLL	→	ACK	Inlet unblocked Dispense Value
DISPENSE VALUE	←		
PAYOUT VALUE POLL	→	VALUE PAID	
ACK	←		
POLL	→	ACK	Inlet blocked, bill transferred from the recycler to the cashbox, or error code
	←		
	• • •		Repeat last 2 commands
PAYOUT VALUE POLL	→	ACK	Payout Complete
PAYOUT STATUS	←		
ACK	→	BILLS PAID	Count of each bill type
BILL DISPENSE STATUS	→	DISPENSER STATUS	Update Bill counts
ACK	← →		

Dispense Sequence w/ bill in escrow			
Controller		Bill Validator	Comments
POLL	→	BILL IN ESCROW	
ACK	←		
	• • •		
ESCROW	→	ACK	Return bill to consumer
	←		
	• • •		

Multi-Drop Bus / Internal Communication Protocol

POLL	→		
	←	BILL ACCEPTED	Bill type and routing (BILL RETURNED)
ACK	→		
POLL	→		
	←	BILL WAITING	Inlet blocked, pending customer
ACK	→		
POLL	→		
	←	ACK	Inlet unblocked
DISPENSE BILL	→		Dispense # of bills
	←	ACK	
PAYOUT VALUE POLL	→		
	←	VALUE PAID	
ACK	→		
POLL	→		
	←	ACK	Inlet blocked, bill transferred from the recycler to the cashbox, or error code
	•		
	•		
	•		Repeat last 2 commands
PAYOUT VALUE POLL	→		
	←	ACK	Payout Complete
PAYOUT STATUS	→		
	←	BILLS PAID	Count of each bill type
ACK	→		
BILL DISPENSE STATUS	→		
	←	DISPENSER STATUS	Update Bill counts
ACK	→		

Value payout w/ bill in escrow			
Controller		Bill Validator	Comments
POLL	→		
	←	BILL IN ESCROW	
ACK	→		
	•		
	•		
	•		
ESCROW	→		
	←	ACK	Return bill to consumer
	•		
	•		
	•		
POLL	→		
	←	BILL ACCEPTED	Bill type and routing (BILL RETURNED)
ACK	→		
POLL	→		
	←	BILL WAITING	Inlet blocked, pending customer

ACK	→		
POLL	→ ←	ACK	Inlet unblocked
DISPENSE VALUE	→ ←	ACK	Dispense value
PAYOUT VALUE POLL	→ ←	VALUE PAID	
ACK	→		
POLL	→ ←	ACK	Inlet blocked, bill transferred from the recycler to the cashbox, or error code
	• • •		Repeat last 2 commands
PAYOUT VALUE POLL	→ ←	ACK	Payout Complete
PAYOUT STATUS	→ ←	BILLS PAID	Count of each bill type
ACK	→		
BILL DISPENSE STATUS	→ ←	DISPENSER STATUS	Update Bill counts
ACK	→		

Operation Cancelled			
Controller		Bill Validator	Comments
	• • •		Payout or dispense in progress
PAYOUT CANCEL	→ ←	ACK	Request to abort consumer
PAYOUT VALUE POLL	→ ←	VALUE PAID	
ACK	→		
POLL	→ ←	ACK	Inlet blocked, bill transferred from the recycler to the cashbox, or error code
	• • •		Repeat last 2 commands
POLL	→ ←	ACK	Inlet unblocked
PAYOUT STATUS	→ ←	BILLS PAID	Count of each bill type
ACK	→		
BILL DISPENSE STATUS	→ ←	DISPENSER STATUS	Update Bill counts
ACK	→		

Multiple Operations

Controller		Bill Validator	Comments
POLL	→ ←	BILL WAITING	Inlet blocked, pending customer
ACK	→		
POLL	→ ←	ACK	Inlet unblocked
DISPENSE BILL	→ ←	ACK	Dispense # of bills
	• • •		
PAYOUT VALUE POLL	→ ←	VALUE PAID	
ACK	→		
POLL	→ ←	ACK	Inlet blocked, bill transferred from the recycler to the cashbox, or error code
	• • •		
PAYOUT VALUE POLL	→ ←	ACK	Payout Complete
PAYOUT STATUS	→ ←	BILLS PAID	Count of each bill type
ACK	→		
BILL DISPENSE STATUS	→ ←	DISPENSER STATUS	Update Bill counts
ACK	→		
POLL	→ ←	BILL WAITING	Inlet blocked, pending customer
ACK	→		
POLL	→ ←	ACK	Inlet unblocked
DISPENSE BILL	→ ←	ACK	Dispense # of bills
	• • •		
PAYOUT VALUE POLL	→ ←	VALUE PAID	
ACK	→		
POLL	→ ←	ACK	Inlet blocked, bill transferred from the recycler to the cashbox, or error code
	• • •		Repeat last 2 commands

PAYOUT VALUE POLL	→ ←	ACK	Payout Complete
PAYOUT STATUS	→ ←	BILLS PAID	Count of each bill type
ACK	→		
BILL DISPENSE STATUS	→ ←	DISPENSER STATUS	Update Bill counts
ACK	→		
POLL	→ ←	BILL WAITING	Inlet blocked, pending customer
ACK	→		
POLL	→ ←	ACK	Inlet unblocked

Section 7

Cashless Device(s)

VMC/Peripheral Communication Specifications

7.1 Introduction

This section defines the communications bytes sent and received between the cashless device(s) and the Vending Machine Controller (VMC). As defined in Section 2.3, there are two cashless device addresses; Cashless #1, 00010xxxB (10H) and Cashless #2, 11000xxxB (60H). The second address has been assigned to allow for two unique forms of cashless devices to be resident in the vending machine simultaneously. An example would be a card based system as Cashless Device #1 (10H) and a mobile phone based system as Cashless Device #2 (60H). **Everything defined in this section will be common to the two cashless devices – only the addresses will be different.**

Unless otherwise stated, all monetary values used by the cashless devices and the VMC will be sixteen bit (Level 01 & 02) or thirty-two bit (Level 03 if 32 bit option enabled), unsigned binary numbers. The numbers will be sent most significant byte first and scaled using the parameters provided by the cashless device's READER CONFIGURATION DATA response.

7.2 State Definitions

MDB cashless devices may be viewed as state machines. These states are as follows:

- 1) Inactive
- 2) Disabled
- 3) Enabled
- 4) Session Idle
- 5) Vend
- 6) Revalue (Level 02/03 cashless devices)
- 7) Negative Vend (Level 03 cashless devices)

7.2.1 Inactive

This is the state of the cashless device at power up or after a reset. While in the Inactive state, cashless devices will NOT be accepted for vending purposes. The cashless device cannot leave this state until all Setup information is received from the VMC.

7.2.2 Disabled

The cashless device automatically enters this state from the Inactive state when it has received the Setup information specified in 7.4.1. It will also enter the Disabled state from the Enabled state when it receives the READER DISABLE command. While in the Disabled state, payment medias will NOT be accepted for vending purposes. The cashless device will remain in this state until either a READER ENABLE command is received (when it will enter the Enabled state) or a RESET is received (when it will enter the Inactive state). For power

management purposes, current consumption will not exceed idle mode specification during disabled state.

7.2.3 Enabled

In this state, cashless devices may be used for MDB transactions. The cashless device will remain in this state until a valid payment media is read (when it will enter the Session Idle state), a READER DISABLE command is received (when it will return to the Disabled state) or a RESET is received (when it will enter the Inactive state).

When the device is enabled to operate in an “always idle” state, a request vend will directly enter the vend session, as well as a negative request vend will directly enter the negative vend request session. During enabled “always idle” state, the cashless device may although perform normal sessions starting with a BEGIN SESSION command – the VMC needs to accept both and should after detecting a BEGIN SESSION response act the whole session like “always idle” state disabled” temporarily.

7.2.4 Session Idle

In the Enabled state, when a valid payment media is processed, the cashless device will issue a BEGIN SESSION response to a VMC POLL and enter the Session Idle state. This indicates that the cashless device is available for vending activities. The only structured exit from the Session Idle state is through the SESSION COMPLETE message from the VMC. The SESSION COMPLETE command will cause the cashless device to respond with an END SESSION message and enable/disable itself appropriately. Vend / Negative Vend / Revalue commands will cause the cashless device to leave the Session Idle state and enter the Vend / Negative Vend / Revalue state when products are selected and purchased.

7.2.5 Always Idle

When the device is able to operate in an “Always Idle” state (enabled with the Optional Feature Bits of the EXPANSION Enable Options command), a VEND REQUEST from the Enabled state will directly enter the Vend state. Additionally, when the device is able to operate in an “Always Idle” state, a NEGATIVE VEND REQUEST will directly enter the Negative Vend Request state.

7.2.5 Vend

This state is entered from the Session Idle state upon reception of a VEND REQUEST message from the VMC. The entire Vend state is an uninterruptable command/response sequence. The cashless device will return to the Session Idle state upon completion of this sequence.

7.2.6 Revalue (Level 02 / 03 Cashless Devices)

This state is entered from the Session Idle state upon reception of a REVALUE REQUEST message from the VMC. The entire Revalue state is an uninterruptable command/response sequence. The cashless device will return to the Session Idle state upon completion of this sequence.

7.2.7 Negative Vend Request (Level 03 Cashless Devices)

This state is entered from the Session Idle state upon reception of a NEGATIVE VEND REQUEST message from the VMC. The entire Negative Vend Request state is an uninterruptable command/response sequence. The cashless device will return to the Session Idle state upon completion of this sequence.

7.3 Command Protocol

After the VMC has issued a command, no new commands may be issued until all data generated in response to that command has been received from the cashless device. The complete response may be an ACK only (e.g. the READER ENABLE command). Alternatively, it may consist of an informational response (e.g. READER CONFIGURATION DATA). The cashless device may provide an informational response in two ways. It may respond immediately with the requested data, or the cashless device may ACK the VMC command. If ACKed, the VMC must issue POLLS until the cashless device responds with the requested data, or until the Application Maximum Response Time (defined in READER CONFIGURATION response) has elapsed.

The cashless device will define the currency type at the beginning of each session. The currency type will be used for all following transactions in that session. If the VMC does not support this currency type, it will end the session.

Below are the uninterruptable VMC commands which require an informational cashless device response and their associated result:

VMC Command	Cashless Device Response	Result
SETUP/CONFIGURATION DATA =>	READER CONFIGURATION DATA	
EXPANSION/REQUEST ID =>	PERIPHERAL ID	
READER CANCEL =>	CANCELLED	
VEND REQUEST... VEND CANCEL =>	VEND DENIED*	
VEND REQUEST =>	VEND DENIED*	
VEND REQUEST =>	VEND APPROVED =>	VEND SUCCESS*
VEND REQUEST =>	VEND APPROVED =>	VEND FAILURE*
NEGATIVE VEND REQUEST =>	NEGATIVE VEND DENIED*	
NEGATIVE VEND REQUEST =>	NEGATIVE VEND APPROVED =>	NEGATIVE VEND SUCCESS*
NEGATIVE VEND REQUEST =>	NEGATIVE VEND APPROVED =>	NEGATIVE VEND FAILURE*
REVALUE REQUEST=>	REVALUE APPROVED/DENIED*	
SESSION COMPLETE =>	END SESSION	

*These VEND / NEGATIVE VEND / REVALUE REQUEST response sequences constitute the Vend / Negative Vend / Revalue Request states.

Below are the uninterruptable POLLED cashless device which require an informational response from the VMC:

VMC Command & Data	Cashless Device Response	Result
POLL =>	DATA ENTRY REQUEST + DISPLAY REQUEST (optional)	
POLL =>	DATA ENTRY CANCEL	Cancelled
DATA ENTRY RESPONSE w/ FFs =>		Cancelled

Any command may be issued by the VMC at anytime providing the above command protocol is observed. There are four exceptions to this rule:

- 1) VEND REQUEST, REVALUE REQUEST, and NEGATIVE VEND REQUEST response sequences may only be initiated in the Session Idle state. In other words, the Cashless Device does not allow an "Always Idle" state unless enabled from setting the corresponding enable bit in the enable options command. If this option is enabled, the VEND REQUEST, the NEGATIVE VEND REQUEST, and the REVALUE REQUEST are allowed also during Enabled state.
- 2) The VMC may issue a VEND CANCEL command after issuing a VEND REQUEST, but before receiving a VEND APPROVED/DENIED response. In this case the cashless device will issue a VEND DENIED response to satisfy the original VEND REQUEST response requirement.
- 3) The cashless device may issue DISPLAY REQUESTs in response to POLLS at any time, if the VMC's display is available for use.
- 4) The RESET command is allowed at any time, it is not subject to any restrictions.

If a VMC command is received by the cashless device while it is in one of the preceding uninterruptable states, the following will occur:

The cashless device will ACK the offending command (no data response will be forthcoming). The cashless device will respond to the next poll with the "COMMAND OUT OF SEQUENCE" response (0BH).

It should be pointed out to cashless device developers that a command out of sequence will always cause the VMC to issue a RESET command to the cashless device.

7.3.1 Multi-Message Response Format

The multi-message response format permits the cashless device to send multiple messages in response to a single command or POLL. Because all messages are of a fixed length, there is no confusion determining where one message ends and the next message begins. (The total message length is subject to the 36 byte limit imposed by Section 2 of this standard.)

For example, if a cashless device fails to correctly write a payment media after a VEND REQUEST, it may need to report:

- 1) VEND DENIED
- 2) MALFUNCTION/ERROR subcode 07h
- 3) SESSION CANCEL REQUEST

The multi-message response (hex) would look like this:

06	0A 07	04	1B*
1	2	3	4

The first byte above (marked 1) is the VEND DENIED message. The next two bytes (marked 2) are the MALFUNCTION/ERROR message. The third and final message is the CANCEL SESSION REQUEST (marked 3). An eight bit checksum with the mode bit set (marked 4) finishes the message.

It is important to note that the controller must service the messages in the order in which they are received. This is necessary to ensure that command protocol is maintained.

7.3.2 Coin Mechanism Escrow Return Actions

If present, the cashless device return button is controlled by the cashless device and it is the responsibility of the cashless device to terminate a vend sequence if the return button is pressed during a vend sequence.

The reaction of the VMC to the coin mechanism escrow return will vary depending upon the state of the system at the time it is pressed. If escrow return is allowed then a coin mechanism escrow return should be interpreted as VEND CANCEL or END OF SESSION.

- 1) In the Enabled state, the VMC should send a READER CANCEL command to the cashless device. This allows the user to abort a pre-approved on-line authorisation request.
- 2) In the Session Idle state, the VMC should send a SESSION COMPLETE command to the cashless device. This will return the cashless device to the Enabled state. The escrow return may cause the system to enter the revalue state prior to the VMC sending the "SESSION COMPLETE" command.
- 3) In the Vend state, before the cashless device has sent a VEND APPROVED or a VEND DENIED, the VMC should send a VEND CANCEL command to the cashless device. This will cancel the vend and cause the cashless device to refund the payment media if necessary.
- 4) In all other cases, no message is sent from the VMC to the cashless device.

TABLE 1: COMMANDS & RESPONSES

Command	Code	Sub-command / Data	Response	VMC / Cashless Level Support
Reset	10H 60H	(none)	No Data *	(Level 01+)
Setup	11H 61H	00H - Config Data	01H - Reader Config Data	(Level 01+)
		01H - Max/Min Prices	No Data *	(Level 01+)
Poll	12H 62H	(none)	00H - Just Reset	(Level 01+)
			01H - Reader Config Data	(Level 01+)
			02H - Display Request	(Level 01+)
			03H - Begin Session	(Level 01+)
			04H - Session Cancel Request	(Level 01+)
			05H - Vend Approved	(Level 01+)
			06H - Vend Denied	(Level 01+)
			07H - End Session	(Level 01+)
			08H - Cancelled	(Level 01+)
			09H - Peripheral ID	(Level 01+)
			0AH - Malfunction / Error	(Level 01+)
			0BH - Cmd Out Of Sequence	(Level 01+)
			0DH - Revalue Approved	(Level 02+) (option)
			0EH - Revalue Denied	(Level 02+) (option)
			0FH - Revalue Limit Amount	(Level 02+) (option)
			10H - User File Data	(Level 02) **
			11H - Time/Date Request	(Level 02+) (option)
			12H - Data Entry Request	(Level 03+) (option)
			13H - Data Entry Cancel	(Level 03+) (option)
			14H - 1AH	(For Future Use)
1BH - FTL REQ TO RCV	(Level 03+) (option)			
1CH - FTL RETRY / DENY	(Level 03+) (option)			
1DH - FTL SEND BLOCK	(Level 03+) (option)			
1EH - FTL OK TO SEND	(Level 03+) (option)			
1FH - FTL REQ TO SEND	(Level 03+) (option)			
20H - FEH	(For Future Use)			
FFH - Diagnostic Response	(Level 01+)			
Vend	13H 63H	00H - Vend Request	05H - Vend Approved	(Level 01+)
			06H - Vend Denied	(Level 01+)

		01H - Vend Cancel	06H - Vend Denied	(Level 01+)
		02H - Vend Success	No Data *	(Level 01+)
		03H - Vend Failure	No Data *	(Level 01+)
		04H - Session Complete	07H - End Session	(Level 01+)
		05H - Cash Sale	No Data *	(Level 01+)
		06H - Negative Vend Request	05H – Vend Approved 06H – Vend Denied	(Level 03+) (option) (Level 03+) (option)
Reader	14H 64H	00H - Reader Disable	No Data *	(Level 01+)
		01H - Reader Enable	No Data *	(Level 01+)
		02H - Reader Cancel	08H - Cancelled	(Level 01+)
		03H - Data Entry Response	No Data *	(Level 03+) (option)
Revalue (option)	15H 65H	00H - Revalue Request	0DH - Revalue Approved 0EH - Revalue Denied	(Level 02+) (option) (Level 02+) (option)
		01H - Revalue Limit Request	0FH - Revalue Limit Amount 0EH - Revalue Denied	(Level 02+) (option) (Level 02+) (option)
Expansion	17H 67H	00H - Request ID	09H - Peripheral ID	(Level 01+)
		01H - Read User File	10H - User File Data	(Level 02) **
		02H - Write User File	No Data *	(Level 02) **
		03H - Write Time/Date (option)	No Data *	(Level 02+) (option)
		04H - Optional Feature Enabled	No Data	(Level 03+)
		FAH - FTL REQ TO RCV (option)	1DH - SEND BLOCK 1CH - RETRY / DENY	(Level 03+) (option) (Level 03+) (option)
		FBH - FTL RETRY / DENY (option)	No Data	(Level 03+) (option)
		FCH - FTL SEND BLOCK (option)	No Data	(Level 03+) (option)
		FDH - FTL OK TO SEND (option)	1DH - SEND BLOCK	(Level 03+) (option)
		FEH - FTL REQ TO SEND (option)	1EH - OK TO SEND 1CH - RETRY/DENY	(Level 03+) (option) (Level 03+) (option)
		FFH - Diagnostics	FFH - Diagnostic Response	(Level 01+)

* No Data response = peripheral just responds with ACK or NAK

** **Obsolete Command – Do not use for new designs. Use EXPANSION - Diagnostics.**

The term (option) indicates that the command/response is a feature enabled by option bits.

NOTE: Cashless device responses which are part of request / response sequences are listed more than once in the above table since the cashless device may respond either immediately to the request (within 5 milliseconds) or to a later POLL.

7.4 VMC/ Cashless Device Command/Response Formats

In the following section, the term “Reader” will indicate either Cashless Device #1 or #2.

7.4.1 Reset and Initialising

RESET (10H / 60H)

Reader response:

No Data response

If this command is received by a cashless device it should terminate any ongoing transaction (with an appropriate credit adjustment, if appropriate), eject the payment media (if applicable), and go to the Inactive state.

All Level 02 and above VMCs must follow the RESET command with the following cashless device initializing sequence: (Any new Level 01 VMCs are recommended to follow the sequence.)

Note that the example shows commands for Cashless Device #1 (10H) only. They would be the same for Cashless Device #2 (address 60H).

POLL – 12h

To obtain “JUST RESET” response

SETUP CONFIGURATION DATA – 11 00h

To send the VMC’s configuration data and obtain the cashless device’s data

SETUP MAX/MIN PRICE – 11 01h

To send the maximum and minimum prices in the VMC. These prices must be sent as Level 01/02 16 bit credit.

EXPANSION REQUEST ID – 17 00h

To obtain additional cashless device information and options (options in Level 03+ only)

EXPANSION ENABLE OPTIONS – 17 04h (Level 03+ only)

To enable desired options

SETUP MAX/MIN PRICE – 11 01h (Level 03+ and option bits 1 & 2 only)

If 32 bit currency option and/or multi currency – multi lingual is enabled (i.e. bits 1 & 2 of expansion enable options), perform **SETUP MAX/MIN PRICE** again to get 32 bit credit and/or user currency – user language (this conditions will be known as EXPANDED CURRENCY MODE in the rest of the document).

READER ENABLE – 14 01h

To enable cashless device (if desired)

7.4.2 SETUP - Config Data

SETUP (11H / 61H)	Config Data (00H) Y1	VMC Feature Level Y2	Columns on Display Y3	Rows On Display Y4	Display Info Y5
----------------------	-------------------------------	-------------------------------	--------------------------------	-----------------------------	-----------------------

- Y1 :** Configuration data.
VMC is sending its configuration data to reader.
- Y2 :** VMC Feature Level.
Indicates the feature level of the VMC. The available feature levels are:
- 01** - The VMC is not capable or will not perform the advanced features as specified in Table 1: COMMANDS & RESPONSES following Section 7.3.2. The reader will not provide advanced information to the VMC, but can do the advanced features internally (transparently to the VMC). The reader has no reevaluation capability.
- 02** - The VMC is capable and willing to perform the advanced features as specified in Table 1: COMMANDS & RESPONSES following Section 7.3.2. The reader will provide advanced information to the VMC (if possible) and will not do the advanced features internally.
- 03** - The VMC is able to support level 02, but also supports some or all of the optional features listed in the EXPANSION ID command (i.e., file transfer, 32 bit credit, multi-currency / language features, negative vend, and / or data entry).
- Y3 :** Columns on Display. The number of columns on the display. Set to 00H if the display is not available to the reader.
- Y4 :** Rows on Display.
The number of rows on the display
- Y5 :** Display Information – xxxxyyy
 xxxxx = Unused
 yyy = Display type
 000 : Numbers, upper case letters, blank and decimal point.
 001 : Full ASCII
 010-111: Unassigned

Reader Response:

Reader Config Data (01H) Z1	Reader Feature Level Z2	Country Code High Z3	Country Code Low Z4	Scale Factor Z5	Decimal Places Z6	Application Maximum Response Time Z7	Miscellaneous Options Z8
---	----------------------------------	-------------------------------	------------------------------	-----------------------	-------------------------	--	--------------------------------

- Z1 :** READER - Configuration data.
Indicates the payment media reader is responding to a SETUP – Configuration data request from the VMC.

Z2 : Reader Feature Level.

Indicates the feature level of the reader. Currently feature levels are:

01 - The reader is not capable or will not perform the advanced features as specified in Table 1: COMMANDS & RESPONSES following Section 7.3.2. The reader will not provide advanced information to the VMC, but can do the advanced features internally (transparently to the VMC). The reader has no revaluation capability.

02 - The reader is capable and willing to perform the advanced features as specified in Table 1: COMMANDS & RESPONSES following Section 7.3.2. The reader will provide advanced information to the VMC (if possible) and will not do the advanced features internally.

03 - The reader is able to support level 02, but also supports some or all of the optional features listed in the EXPANSION ID command (i.e., file transfer, 32 bit credit, multi-currency / language features, negative vend, and / or data entry).

Z3-Z4 : Country / Currency Code - packed BCD.

The packed BCD country / currency code of the reader can be sent in two different forms depending on the value of the left most BCD digit.

If the left most digit is a 0, the International Telephone Code is used to indicate the country that the reader is set-up for. For example, the USA code is 00 01H (Z3 = 00 and Z4 = 01).

If the left most digit is a 1, the latest version of the ISO 4217 numeric currency code is used (see Appendix A1). For example, the code for the US dollar is 18 40H (Z2 = 18 and Z3 = 40) and for the Euro is 19 78 (Z3 = 19 and Z4 = 78). Use FFFFh if the country code is unknown.

For level 3 cashless devices, it is mandatory to use the ISO 4217 numeric currency code (see Appendix A1).

Z5 : Scale Factor.

The multiplier used to scale all monetary values transferred between the VMC and the reader.

Z6 : Decimal Places.

The number of decimal places used to communicate monetary values between the VMC and the payment media reader.

All pricing information sent between the VMC and the payment media reader is scaled using the scale factor and decimal places. This corresponds to:

$$\text{ActualPrice} = P \cdot X \cdot 10^{-Y}$$

where P is the scaled value sent in the price bytes, and X is the scale factor, and Y is the number of decimal places. For example if there are 2 decimal places and the scale factor is 5, then a scaled price of 7 will mean an actual of 0.35.

- Z7 :** Application Maximum Response Time - seconds.
 The maximum length of time a reader will require to provide a response to any command from the VMC. The value reported here supercedes the payment reader's default NON-RESPONSE time defined in section 7.5 if the value reported here is greater. (See Section 7.5)
- Z8 :** Miscellaneous Options – xxxxyyyy
 xxxx: Unused (must be set to 0)
 yyyy: Option bits
 b0=0: The payment media reader is NOT capable of restoring funds to the user's payment media or account. Do not request refunds.
 b0=1: The payment media reader is capable of restoring funds to the user's payment media or account. Refunds may be requested.
 b1=0: The payment media reader is NOT multivend capable. Terminate session after each vend.
 b1=1: The payment media reader is multivend capable. Multiple items may be purchased within a single session.
 b2=0: The payment media reader does NOT have a display.
 b2=1: The payment media reader does have its own display.
 b3=0: The payment media reader does NOT support the VEND/CASH SALE subcommand.
 b3=1: The payment media reader does support the VEND/CASH SALE subcommand.
 b4-b7=0 **Any future options must be covered by the EXPANSION COMMAND option bits.**

7.4.3 SETUP – Max / Min Prices

SETUP (11H / 61H)	Max / Min Prices (01H) Y1	Maximum Price Y2-Y3	Minimum Price Y4-Y5
----------------------	------------------------------------	---------------------------	---------------------------

Level 01 / 02 / 03 Readers

- Y1 :** Max / Min prices
 Indicates the VMC is sending the price range to the reader.
- Y2 - Y3 :** Maximum Price – scaled
 This information should be sent as soon as the VMC prices have been established and any time there is a change in the maximum price, If the VMC does not know the maximum price, FFFFh should be sent.
- Y4 -Y5 :** Minimum Price – scaled
 This information should be sent as soon as the VMC prices have been established and any time there is a change in the minimum price. If the VMC does not know the minimum price, 0000h should be sent.

SETUP (11H / 61H)	Max / MinPrices (01H) Y1	Maximum Price Y2-Y5	Minimum Price Y6-Y9	Currency Code Y10-Y11
----------------------	-----------------------------------	---------------------------	---------------------------	-----------------------------

Level 03 (EXPANDED CURRENCY MODE) Readers

- Y1 :** Max / Min prices
Indicates the VMC is sending the price range to the reader.
- Y2 – Y5 :** Maximum Price – scaled
This information should be sent as soon as the VMC prices have been established and any time there is a change in the maximum price, If the VMC does not know the maximum price, FFFFFFFFh should be sent.
- Y6 –Y9 :** Minimum Price – scaled
This information should be sent as soon as the VMC prices have been established and any time there is a change in the minimum price. If the VMC does not know the minimum price, 00000000h should be sent.
- Y10-Y11** Currency Code
The currency code used during this command per ISO 4217 (see Appendix A1). The value is configured as packed BCD with the leading digit a 1 (one). For example, the code for the US dollar would be 1840 (Z10 = 18 and Z11 = 40). and for the Euro is 1978 (Z10 = 19 and Z11 = 78).

Reader response:

No Data response

7.4.4 POLL

POLL (12H / 62H)

The POLL command is used by the VMC to obtain information from the payment media reader. This information may include user actions (CANCEL SESSION REQUEST), hardware malfunctions (MALFUNCTION /ERROR), software malfunctions (COMMAND OUT OF SEQUENCE) or information explicitly requested by the controller (READER CONFIGURATION DATA). An ACK response indicates that no error states exist, and either no information request is pending or pending information is not yet ready for transmission.

In addition to an ACK, the VMC may receive the following POLL responses from the payment media reader.

Begin Session (03H)	Funds Available
Z1	Z2-Z3

Level 01 Readers

- Z1 :** BEGIN SESSION (**level 01 readers**)
Allow a patron to make a selection, but do not dispense product until funds are approved.
- Z2-Z3 :** Funds Available – scaled
 - a. Lesser of the user’s payment media or account balance or FFFEh units.
 - b. Not yet determined - FFFFh. (Allows selection without displaying balance)

Begin Session (03H)	Funds Available	Payment media ID	Payment Type	Payment Data
Z1	Z2-Z3	Z4-Z7	Z8	Z9-Z10

Level 02 / 03 Readers

- Z1 :** BEGIN SESSION (**level 02/03 readers**)
Allow a patron to make a selection, but do not dispense product until funds are approved.
- Z2-Z3 :** Funds Available – scaled
 - a. Lesser of the user’s payment media or account balance or FFFEh units.
 - b. Not yet determined - FFFFh. (Allows selection without displaying balance)
- Z4-Z7 :** Payment media ID.
0000000h-FFFFFFEh=Payment media identification number.
FFFFFFFh = unknown payment media ID.
- Z8 :** Type of payment:
 - 00xxxxxb = normal vend card (refer EVA-DTS Standard, Appendix A.1.1 Definitions)
 - x1xxxxxb = test media
 - 1xxxxxb = free vend card
 - xx00000b -0 VMC default prices.
 - xx00001b -1 User Group (Z9 = EVA-DTS Element DA701)
Price list number (Z10 = EVA-DTS Element LA101)*
 - xx00010b -2 User Group (Z9 = EVA-DTS Element DA701)
Discount group index (Z10 = EVA-DTS Element MA403)
 - xx00011b -3 Discount percentage factor (Z9=00, Z10 = 0 to 100**, report as positive value in EVA-DTS Element MA404)

xx000100b -4 Surcharge percentage factor (Z9=00, Z10 = 0 to 100**, report as negative value in EVA-DTS Element MA404)

* User Group is a segmentation of all authorized users. It allows selective cost allocation. A User Group usually has no direct relation to a price list.
 Price Lists are tables of prices. Each Price List contains an individual price for each product.
 Discount Group indicates the Price List on which the Percentage Factor will be applied.
 If the User Group, the Price List or Discount Group is unknown by the VMC, the normal prices are used (Z8 is defaulted to 00h).
 Minimum value for Z9 and Z10 is 0.

** Percentages are expressed in binary (00 to 64h)

Note:

These functions may NOT be supported by all VMCs.

Z9-Z10 : Payment data as defined above.

Begin Session (03H)	Funds Available	Payment media ID	Payment Type	Payment Data	User Language	User Currency Code	Card Options
Z1	Z2-Z5	Z6-Z9	Z10	Z11-Z12	Z13-Z14	Z15-Z16	Z17

Level 03 (EXPANDED CURRENCY MODE) Readers

Z1 : BEGIN SESSION (**level 03 readers / EXPANDED CURRENCY MODE**)
 Allow a patron to make a selection, but do not dispense product until funds are approved.

Z2-Z5 : Funds Available – scaled
 a. Lesser of the user’s payment media or account balance or FFFFFFFEh units.
 b. Not yet determined - FFFFFFFFh.

Z6-Z9 : Payment media ID.
 00000000h-FFFFFFFEh=Payment media identification number.
 FFFFFFFFh = unknown payment media ID.

Z10 : Type of payment:
 00xxxxxb = normal vend card (refer EVA-DTS Standard, Appendix A.1.1 Definitions)
 x1xxxxxb = test media
 1xxxxxb = free vend card
 xx000000b -0 VMC default prices.

xx000001b	-1 User Group	(Z11 = EVA-DTS Element DA701)
	Price list number	(Z12 = EVA-DTS Element LA101)*
xx000010b	-2 User Group	(Z11 = EVA-DTS Element DA701)
	Discount group index	(Z12 = EVA-DTS Element MA403)
xx000011b	-3 Discount percentage factor	(Z11=00, Z12 = 0 to 100**, report as positive value in EVA-DTS Element MA404)
xx000100b	-4 Surcharge percentage factor	(Z11=00, Z12 = 0 to 100**, report as negative value in EVA-DTS Element MA404)

* User Group is a segmentation of all authorized users. It allows selective cost allocation. A User Group usually has no direct relation to a price list.

Price Lists are tables of prices. Each Price List contains an individual price for each product.

Discount Group indicates the Price List on which the Percentage Factor will be applied.

If the User Group, the Price List or Discount Group is unknown by the VMC, the normal prices are used (Z10 is defaulted to 00h).

Minimum value for Z11 and Z12 is 0.

** Percentages are expressed in binary (00 to 64h)

Note:

These functions may NOT be supported by all VMCs.

Z11-Z12: Payment data as defined above.

Z13-Z14 User language to use during this session (2 ASCII characters per ISO 639:latest version). The user language is read from the patrons card and, if supported, should be used instead of the VMC default language (taken according to the setup command International Telephone code) up to the next "session complete". If the VMC is not able to support this language, the default setting should be used.

Z15-Z16 User currency code to use during this session per ISO 4217 (see Appendix A1). The value is configured as packed BCD with the leading digit a 1 (one). For example, the code for the US dollar would be 1840 (Z15 = 18 and Z16 = 40). and for the Euro is 1978 (Z6 = 19 and Z7 = 78).

Z17 Card options (overrides any previous default settings for reader)

b0=0: The VMC displays the credit if it is programmed to do so

b0=1: The VMC **must not display** the credit (privacy purpose – user option)

b1=0: The actual inserted patrons card has no refund capability

b1=1: The actual inserted patrons card has refund capability (Note: a reader with refund capability may be used with both type of cards)

b2=0 The actual inserted patrons card has no revalue capability

b2=1 The actual inserted patrons card has revalue & negative vend

capability
 b3-b7: Reserved for future extensions (unused bits must be set to 0)

Refund means the ability to put money back on the inserted patrons card up to the value of the last transaction. Revalue means the ability to put money back on the inserted patrons card up to any value.

The card reader will define the currency type at the beginning of each card session. **The currency type will be used for all following transactions in that session. If the VMC does not support this currency type, it will end the session.**

Session Cancel Request (04H) Z1
--

Z1 : SESSION CANCEL REQUEST
 The payment media reader is requesting the VMC to cancel the session. The VMC should initiate an eventual SESSION COMPLETE. This response is sent to the VMC whenever the payment media is removed or a request for removal from the reader is made by the user (e.g. if a return button on the reader is pressed).

Vend Approved (05H) Z1	Vend Amount Z2-Z3
---------------------------------	-------------------------

Level 01 / 02 / 03 Readers

Refer to paragraph 7.4.5 for detailed explanation.

Vend Approved (05H) Z1	Vend Amount Z2-Z5
---------------------------------	-------------------------

Level 03 (EXPANDED CURRENCY MODE) Readers

Refer to paragraph 7.4.5 for detailed explanation.

Vend Denied (06H) Z1

Refer to paragraph 7.4.5 for detailed explanation.

End Session (07H) Z1

Refer to paragraph 7.4.9 for detailed explanation.

Cancelled (08H) Z1

Refer to paragraph 7.4.14 for detailed explanation.

Peripheral ID (09H)	Manufacturer Code	Serial Number	Model Number	Software Version
Z1	Z2-Z4	Z5-Z16	Z17-Z28	Z29-Z30

Level 01 / 02 / 03 Readers (If VMC indicates Level 01 or 02)

- Z1 :** PERIPHERAL ID
Reader is sending peripheral ID information.
- Z2 - Z4 :** Manufacturer Code - ASCII
Identification code for the equipment supplier. Currently defined codes are listed in the **EVA** document entitled "**European Vending Association Data Transfer Standard**" (**EVA-DTS**), the Audit Data Lists section, sub-section 2, "Manufacturer Codes".
- Z5-Z16 :** Serial Number – ASCII
Factory assigned serial number.
- Z17-Z28 :** Model Number - ASCII
Manufacturer assigned model number.
- Z29-Z30 :** Software Version - packed BCD
Current software version.

Peripheral ID (09H)	Manufacturer Code	Serial Number	Model Number	Software Version	Optional Feature bits
Z1	Z2-Z4	Z5-Z16	Z17-Z28	Z29-Z30	Z31 - Z34

Level 03 Readers (If VMC indicates Level 03)

- Z1 :** PERIPHERAL ID

Reader is sending peripheral ID information.

- Z2 - Z4 :** Manufacturer Code - ASCII
Identification code for the equipment supplier. Currently defined codes are listed in the **EVA** document entitled "**European Vending Association Data Transfer Standard**" (**EVA-DTS**), the Audit Data Lists section, sub-section 2, "Manufacturer Codes".
- Z5-Z16 :** Serial Number – ASCII
Factory assigned serial number.
- Z17-Z28 :** Model Number - ASCII
Manufacturer assigned model number.
- Z29-Z30 :** Software Version - packed BCD
Current software version.
- Z31- Z34** Optional Feature Bits. Each of the 32 bits indicate an optional feature availability. Bits should be sent in descending order, i.e. bit 31 is sent first and bit 0 is sent last. Options **must be enabled by the VMC** using the Expansion Optional Feature Bit Enable (17H-04H) command and **all features are disabled after a reset**. Currently defined options are:

- b0 - File Transport Layer supported
- b1 - 0 = 16 bit monetary format, 1 = 32 bit monetary format
- b2 – support multi currency / multi lingual
- b3 – allow Negative Vend
- b4 – allow data entry
- b5 – allow “Always Idle” state
- b6 to b31 not used (should be set to 0)

Note: If 32 bit monetary format (b1) and or multi currency / multi lingual (b2) options are enabled, this condition will be known as **EXPANDED CURRENCY MODE** in the rest of the document.

Malfunction / Error	Error Code
(0AH) Z1	Z2

- Z1 :** MALFUNCTION/ERROR
The payment media reader is reporting a malfunction or error.
- Z2 :** Error Code – xxxxyyyy
 - xxxx error types
 - 0000: Payment media Error1
 - 0001: Invalid Payment media1
 - 0010: Tamper Error1
 - 0011: Manufacturer Defined Error1

0100:	Communications Error ²
0101:	Reader Requires Service ²
0110:	Unassigned ²
0111:	Manufacturer Defined Error ²
1000:	Reader Failure ³
1001:	Communications Error ³
1010:	Payment media Jammed ³
1011:	Manufacturer Defined Error
1100:	Refund error – internal reader credit lost
1101-1111:	Unassigned

1 Transient error - Reported once

2 Non-transient error - Reported every POLL until cleared. Reader still functional.

3 Non-transient error - Reported every POLL until cleared. Reader not presently functional.

yyyy = Manufacturer defined subcode

Transient Error Handling

The error will be reported to the VMC until it has been ACKnowledged. The error state will be cleared in the reader, and normal operations will continue.

Non-transient Error Handling

The error will be reported to the VMC at each POLL as long as it exists. If the reader is still functional, multi-message responses will allow normal responses in addition to the error report.

Note: Refund error is sent from the media reader when it is not able to refund money to the payment media following a failed or cancelled vend. The reader internally cancels the credit and the credit is lost.

Command Out of Sequence (0BH) Z1
--

Level 01 Readers

Z1 : COMMAND OUT OF SEQUENCE (Level 01 readers)
The payment media reader has received a command that is not executable in its current state, or that violates one of the uninterruptable sequences. The offending command should be ACKed but not acted upon the reader. The VMC will send the RESET command to the reader upon reception of this response. Note that the reader will continue with

any credit update process prior to resetting.

Command Out of Sequence (0BH) Z1	Status Z2
--	--------------------------

Level 02 / 03 Readers

Z1 : COMMAND OUT OF SEQUENCE. (Level 02/03 readers)
The payment media reader has received a command that is not executable in its current state, or that violates one of the uninterruptable sequences. The offending command should be ACKed but not acted upon the reader. The VMC will send the RESET command to the reader upon reception of this response. Note that the reader will continue with any credit update process prior to resetting.

Z2 : Status
The state of the payment media reader.
01: Inactive state
02: Disabled state
03: Enabled state
04: Session idle state
05: Vend state
06: Revalue state
07: Negative Vend state

Revalue Approved (0DH) Z1

Level 02 / 03 Readers

Refer to paragraph 7.4.16 for detailed explanation.

Revalue Denied (0EH) Z1

Level 02 / 03 Readers

Refer to paragraph 7.4.16 for detailed explanation.

Revalue	Revalue
---------	---------

Limit Amount (OFH)	Limit Amount
Z1	Z2-Z3

Level 02 / 03 Readers

Refer to paragraph 7.4.17 for detailed explanation.

Revalue Limit Amount (0FH) Z1	Revalue Limit Amount Z2-Z5
--	--------------------------------------

Level 03 (EXPANDED CURRENCY MODE) Readers

Refer to paragraph 7.4.17 for detailed explanation.

User File Data (10H) Z1	Number of User File Z2	Length Of User File Z3	User Data Z4-Zn
----------------------------------	----------------------------------	----------------------------------	---------------------------

Level 02 Readers

Obsolete Response – Do not use for new designs!! (Use EXPANSION – Diagnostics)

Refer to paragraph 7.4.19 for detailed explanation.

Time/Date Request (11H) Z1

Level 02 / 03 Readers

- Z1 :** TIME DATE REQUEST
In certain circumstances it will be necessary to synchronize the real time clock of the card reader with real time clock of the VMC. The card reader will respond with TIME/DATE REQUEST to a POLL command of the VMC. The VMC will follow with the EXPANSION-WRITE TIME/DATE FILE to the card reader. Refer to paragraph 7.4.19.

Data Entry Request Response (12H) Z1	Data Entry Length and Repeat Bit Z2
---	--

Level 03 Readers (if Data Entry option enabled)

- Z1 :** DATA ENTRY REQUEST
The reader is making a DATA ENTRY REQUEST.
- Z2 :** DATA ENTRY LENGTH and REPEAT BIT
rnnnnnnnn
r – Repeat Bit (0 = initial request / 1 = repeated requests
nnnnnnn – number of requested characters / keys

Depending on the type of data being entered, it is a higher level system decision on whether or not the data is displayed on either the vending machine or card reader. If the data is not displayed (a recommendation for certain types of sensitive data) the vending machine or card reader display can still be optionally used to indicate a prompt and/or representation of the data entered for user feedback (i.e., asterisks *****).

If the card reader uses the vending machine's display for Data Entry information, it **must concatenate** the DATA ENTRY REQUEST Response (12H) with the DISPLAY REQUEST response (02H). Upon receipt of the response pair, the vending machine controller will give its display to the card reader for the duration of the Data Entry session plus the amount of time specified in the Z2 Display Time following the end of the session (regardless of a normal or cancelled session). In essence, the vending machine controller will not write anything to its display during the Data Entry session plus the Z2 time. The reader will be able to update the Data Entry information on the vending machine's display by sending additional DISPLAY REQUEST responses during the Data Entry session.

Please see additional DATA ENTRY procedures in Section 7.4.15.

Data Entry Cancel (13H) Z1

Level 03 Readers (if Data Entry option enabled)

- Z1 :** DATA ENTRY CANCEL
The user has pushed the reader's RETURN button before completing the DATA ENTRY. The VMC should terminate all DATA ENTRY activity in progress.

FTL REQ TO RCV (1BH) Z1

Level 03 Readers (if File Transport Layer option enabled)

- Z1 :** **FTL REQ TO RCV**
The reader is requesting to receive data from a device or VMC.
- Z2 :** **FTL Destination Address**
The destination address of the response as defined in Section 2.6.
- Z3 :** **FTL Source Address (Reader = 10H / 60H)**
The source address of the response as defined in Section 2.6.
- Z4 :** **FTL File ID**
The type of information desired as defined in Section 2.6.
- Z5 :** **FTL Maximum Length**
The total number of blocks in the file as defined in Section 2.6.
- Z6 :** **FTL Control**
Data transfer control information as defined in Section 2.6.

FTL RETRY/DENY (1CH) Z1

Level 03 Readers (if File Transport Layer option enabled)

- Z1 :** **FTL RETRY / DENY**
The reader is requesting a device or VMC to retry or deny the last FTL command.
- Z2 :** **FTL Destination Address**
The destination address of the response as defined in Section 2.6.
- Z3 :** **FTL Source Address (Reader = 10H / 60H)**
The source address of the response as defined in Section 2.6.
- Z4 :** **FTL Retry Delay**
The retry delay as defined in Section 2.6.

FTL
SEND
BLOCK
(1DH)
Z1

Level 03 Readers (if File Transport Layer option enabled)

- Z1 :** **FTL SEND BLOCK**
The reader is sending a block of data (maximum of 31 bytes) to a device or VMC.
- Z2 :** **FTL Destination Address**
The destination address of the response as defined in Section 2.6.
- Z3 :** **FTL Block #**
The sequential number of the block as defined in Section 2.6.
- Z4- Z34** **FTL Data (maximum of 31 bytes)**
: The actual data portion of the block as defined in Section 2.6.

FTL
OK TO SEND
(1EH)
Z1

Level 03 Readers (if File Transport Layer option enabled)

- Z1 :** **FTL OK TO SEND**
The reader is indicating that it is OK for the device or VMC to send it data.
- Z2 :** **FTL Destination Address**
The destination address of the response as defined in Section 2.6.
- Z3 :** **FTL Source Address (Reader = 10H / 60H)**
The source address of the response as defined in Section 2.6.

FTL REQ TO SEND (1FH) Z1

Level 03 Readers (if File Transport Layer option enabled)

- Z1 :** **FTL REQ TO SEND**
The reader is requesting to send data to a device or VMC.
- Z2 :** **FTL Destination Address**
The destination address of the response as defined in Section 2.6.
- Z3 :** **FTL Source Address (Reader = 10H / 60H)**
The source address of the response as defined in Section 2.6.
- Z4 :** **FTL File ID**
The type of information desired as defined in Section 2.6.
- Z5 :** **FTL Maximum Length**
The total number of blocks in the file as defined in Section 2.6.
- Z6 :** **FTL Control**
Data transfer control information as defined in Section 2.6.

Diagnostics Response (FFH) Z1	User Defined Data Z2-Zn
--	----------------------------------

Refer to paragraph 7.4.28 for detailed explanation.

7.4.5 VEND - Request

Vend (13H / 63H) Y1	Vend Request (00H) Y2-Y3	Item Price Y4-Y5	Item Number
---------------------------	-----------------------------------	------------------------	----------------

Level 01 / 02 / 03 Readers

- Y1 :** **VEND REQUEST**
The patron has made a selection. The VMC is requesting vend approval from the payment media reader before dispensing the product.
- Y2-Y3 :** **Item Price - scaled**
The price of the selected product.

Y4-Y5 : Item Number

The item number of the selected product. This number is defined by the manufacturer, and set to FFFFh for undefined or not implemented.

Reader response:

Vend Approved (05H) Z1	Vend Amount Z2-Z3
---------------------------------	-----------------------------

Z1 : VEND APPROVED
Allow the selected product to be dispensed.

Z2-Z3 : Vend Amount - scaled
This is the amount deducted from the user's payment media or account. This may not match the amount specified in the VEND REQUEST command; it may be surcharged or discounted.
FFFFh - an electronic token was used.

NOTE: The VMC must use Vend Amount to update the credit on the screen. The Reader must fill this field with the used amount for the transaction.

Vend Denied (06H) Z1

Z1 : VEND DENIED
Approval denied for the patron's selection. Do not dispense any products.

Vend (13H / 63H)	Vend Request (00H) Y1	Item Price Y2-Y5	Item Number Y6-Y7
---------------------	--------------------------------	------------------------	-------------------------

Level 03 (EXPANDED CURRENCY MODE) Readers

Y1 : VEND REQUEST
The patron has made a selection. The VMC is requesting vend approval from the payment media reader before dispensing the product.

Y2-Y5 : Item Price – scaled
The price of the selected product.

Y6-Y7 : Item Number
The item number of the selected product. This number is defined by the manufacturer, and set to FFFFh for undefined or not implemented.

Reader Response:

Vend Approved (05H) Z1	Vend Amount Z2-Z5
---------------------------------	-------------------------

Level 03 (EXPANDED CURRENCY MODE) Readers

- Z1 :** VEND APPROVED
Allow the selected product to be dispensed.
- Z2-Z5 :** Vend Amount - scaled
This is the amount deducted from the user's payment media or account.
This may not match the amount specified in the VEND REQUEST
command; it may be surcharged or discounted.
FFFFFFFFh - an electronic token was used.

NOTE: The VMC must use Vend Amount to update the credit on the screen. The Reader must fill this field with the used amount for the transaction.

7.4.6 VEND - Cancel

Vend (13H / 63H)	Vend Cancel (01H) Y1
---------------------	-------------------------------

Y1 : VEND CANCEL

This command can be issued by the VMC to cancel a VEND REQUEST command before a VEND APPROVED/DENIED has been sent by the payment media reader. The payment media reader will respond to VEND CANCEL with a VEND DENIED and return to the Session Idle state.

Reader response:

Vend Denied (06H) Z1

See paragraph 7.4.5 for explanation.

7.4.7 VEND - Success

Vend (13H / 63H)	Vend Success (02H) Y1	Item Number Y2-Y3
---------------------	--------------------------------	-------------------------

Y1 : VEND SUCCESS

The selected product has been successfully dispensed.

Y2-Y3 : Item number

The item number of the selected product. This number is defined by the manufacturer, and set to FFFFh for undefined or not implemented.

NOTE A reset between VEND APPROVED and VEND SUCCESS shall be interpreted as a VEND SUCCESS.

Reader response:

No Data response

7.4.8 VEND - Failure

Vend (13H / 63H)	Vend Failure (03H) Y1
---------------------	--------------------------------

Y1 : VEND FAILURE

A vend has been attempted at the VMC but a problem has been detected and the vend has failed. The product was not dispensed. Funds should be refunded to user's account.

Reader response:

No Data response

Vend failure sequence

In order to ensure that a reader refunds after a Vend Failure command, the VMC must send at least a single Poll command to obtain the reader possible answers:

ACK	Refund Complete
MALFUNCTION ERROR code 1100yyyy	Refund error-internal reader credit lost
SILENCE	Refund in progress. VMC must repoll reader until ACK or Malfunction error answer for maximum NON Response time.

7.4.9 SESSION COMPLETE

Vend (13H / 63H)	Session Complete (04H) Y1
---------------------	------------------------------------

Y1 : SESSION COMPLETE

This tells the payment media reader that the session is complete and to return to the Enabled state. SESSION COMPLETE is part of a command/response sequence that requires an END SESSION response from the reader.

Reader response:

End Session (07H) Z1

- Z1 :** END SESSION
This command is issued in response to a SESSION COMPLETE command. The END SESSION response indicates the reader has returned to the Enabled state. If “END SESSION” is not received by the VMC within a the maximum application non-response time, the VMC must issue a “RESET” command.

7.4.10 CASH SALE

Vend (13H / 63H)	Cash Sale (05H) Y1	Item Price Y2-Y3	Item Number Y4-Y5
---------------------	-----------------------------	------------------------	-------------------------

Level 01 / 02 / 03 Readers

- Y1 :** CASH SALE
A cash sale (cash only or cash and cashless) has been successfully completed by the VMC.
- Y2-Y3 :** Item Price – scaled
The price of the selected product or cash portion of the price.
- Y4-Y5 :** Item Number
The item number of the selected product. This number is defined by the manufacturer, and set to FFFFh for undefined or not implemented.

Note: This command is issued for cash auditing applications and is sent to the payment media reader if the SETUP/CONFIGURATION bit (b3) is enabled anytime a valid cash transaction is completed via a coin mechanism or bill validator.

Reporting of free vends, token vends, etc. should commonly be done, using the following item number conventions:

- Set bit b15 in item number to signal the cash vend as a free vend
- Set bit b14 in item number to signal the cash vend as a test vend
- Set bit b13 in item number to signal the cash vend as a negative vend (an item was returned and cash was payed out)
- Set bit b12 in item number to signal the cash vend as a token vend

Reader response:

No Data response

Vend (13H)	Cash Sale (05H) Y1	Item Price Y2-Y5	Item Number Y6-Y7	Item Currency Y8-Y9
---------------	-----------------------------	------------------------	-------------------------	---------------------------

Level 03 (EXPANDED CURRENCY MODE) Readers

- Y1 :** CASH SALE
A cash sale (cash only or cash and cashless) has been successfully completed by the VMC.
- Y2-Y5 :** Item Price – scaled
The price of the selected product or cash portion of the price.
- Y6-Y7 :** Item Number
The item number of the selected product. This number is defined by the manufacturer, and set to FFFFh for undefined or not implemented.
- Y8-Y9 :** Item Currency
The currency for the item price used during the vend. This value may be converted within the reader to the readers balancing currency. The item currency is sent using the numeric code as defined in ISO 4217 (see Appendix A1). The value is configured as packed BCD with the leading digit a 1 (one). For example, the code for the US dollar would be 1840 (Z10 = 18 and Z11 = 40). and for the Euro is 1978 (Z10 = 19 and Z11 = 78).

Note: This command is issued for cash auditing applications and is sent to the payment media reader if the SETUP/CONFIGURATION bit (b3) is enabled anytime a valid cash transaction is completed via a coin mechanism or bill validator.

Reader response:

No Data response

7.4.11 Negative Vend Request

Vend (13H / 63H)	Neg.Vend Request (06H) Y1	Item Value Y2-Y3	Item Number Y4-Y5
---------------------	------------------------------------	------------------------	-------------------------

Level 03 Reader

- Y1 :** NEGATIVE VEND REQUEST

The patron has inserted an item. The VMC is requesting negative vend approval from the payment media reader before accepting the returned product.

Y2-Y3 : Item value – scaled
The value of the inserted product (16 Bit).

Y4-Y5 : Item Number
The item number of the inserted product. This number is defined by the manufacturer, and set to FFFFh for undefined or not implemented.

Reader response:

Vend Approved (05H) Z1	Vend Amount Z2-Z3
---------------------------	----------------------

Level 03 (EXPANDED CURRENCY MODE disabled) Readers

Z1 : VEND APPROVED
Allow the returned product to be accepted, i.e. this means, the reader will be able to credit the value to the patrons card, when a vend success will follow the approved.

Z2-Z3 : Vend Amount – scaled
This is the amount of credit, which will be added to the user's payment media or account. This may not match the amount specified in the NEGATIVE VEND REQUEST command; it may be surcharged or discounted.
FFFFh - an electronic token will be credited.

Vend (13H / 63H) Y1	Neg.Vend Request (06H) Y1	Item Value Y2-Y5	Item Number Y6-Y7
------------------------	------------------------------	---------------------	----------------------

Level 03 (EXPANDED CURRENCY MODE) Readers

Y1 : NEGATIVE VEND REQUEST
The patron has inserted an item. The VMC is requesting negative vend approval from the payment media reader before accepting the returned product.

Y2-Y5 : Item value – scaled

The value of the inserted product.

Y6-Y7 : Item Number

The item number of the inserted product. This number is defined by the manufacturer, and set to FFFFh for undefined or not implemented.

Reader response:

Vend Approved (05H) Z1	Vend Amount Z2-Z5
---------------------------------	-----------------------------

Level 03 (EXPANDED CURRENCY MODE) Readers

Z1 : VEND APPROVED

Allow the returned product to be accepted, i.e. this means, the reader will be able to credit the value to the patrons card, when a vend success will follow the approved.

Z2-Z5 : Vend Amount – scaled

This is the amount of credit, which will be added to the user's payment media or account. This may not match the amount specified in the NEGATIVE VEND REQUEST command; it may be surcharged or discounted.

FFFFFFFFh - an electronic token will be credited.

Vend Denied (06H) Z1

Z1 : VEND DENIED

Approval denied for the returned product. Do not accept the product or return it if possible.

Note: This command is used in the uninterruptable vend sequence like the normal REQUEST VEND and is followed by the normal responses VEND APPROVED or VEND DENIED, for the reader to confirm the credit update possibility and the final VEND SUCCESS or VEND FAILURE command to update the patron's credit.

Designers of cashless devices must pay special attention in implementing this command, especially for non locking readers. Credit should only be generated on the media upon final reception of VEND SUCCESS to avoid unwanted credit in the system.

Designers of both the VMC and the readers have to deal with fault conditions of such a system carefully. A normal sequence description is added to the example vend sessions with hints to different application features.

7.4.12 READER - Disable

Reader (14H / 64H)	Disable (00H) Y1
-----------------------	------------------------

Y1 : READER DISABLE

This informs the payment media reader that it has been disabled, i.e. it should no longer accept a patron's payment media for the purpose of vending. Vending activities may be re-enabled using the READER ENABLE command. The payment media reader should retain all SETUP information.

NOTE Any transaction in progress will not be affected and should continue to its normal completion.

Reader response:

No Data response

7.4.13 READER - Enable

Reader (14H / 64H)	Enable (01H) Y1
-----------------------	-----------------------

Y1 : READER ENABLE

This informs the payment media reader that it has been enabled, i.e. it should now accept a patron's payment media for vending purposes. This command must be issued to a reader in the Disabled state to enable vending operations.

Reader response:

No Data response

7.4.14 READER - Cancel

Reader (14H / 64H)	Cancel (02H) Y1
-----------------------	-----------------------

- Y1 :** READER CANCEL
This command is issued to abort payment media reader activities which occur in the Enabled state. It is the first part of a command/response sequence which requires a CANCELLED response from the reader.

Reader response:

Cancelled (08H) Z1

- Z1 :** CANCELLED
This is the reader's response to the READER CANCEL command from the VMC. This command comprises a command/response sequence. Its use is only appropriate in the Enabled state.

7.4.15 DATA ENTRY – Response (Key Entries)

The purpose of the overall Data Entry request / response sequence is to allow the machine user to enter data (i.e., a card validation number) using the selection buttons on the vending machine.

The DATA ENTRY request / response sequence can occur in the Enabled state only. It is the responsibility of the reader to enforce this rule.

Depending on the type of data being entered, it is a higher level system decision on whether or not the data is displayed on either the vending machine or card reader. If the data is not displayed (a recommendation for certain types of sensitive data) the vending machine or card reader display can still be optionally used to indicate a prompt and/or representation of the data entered for user feedback (i.e., asterisks *****). **Please see additional information on the vending machine's display usage for Data Entry in the DATA ENTRY REQUEST Response (12H) description in the 7.4.4 POLL section.**

The DATA ENTRY RESPONSE key entries are sent to the reader as they are pressed. Depending on the user's speed of entry and vending machine controller cycle time, the data may be sent either as a digit at a time, a sub group of digits, or the entire length of digits as specified in the Z2 Data Entry Length byte in the DATA ENTRY REQUEST response. For example, if the Data Entry Length is 6 digits, but only 2 are initially (and quickly) entered, the vending machine controller will send the 2 that are available via the DATA ENTRY

RESPONSE Y2-Y9 command. The balance will be sent via other DATA ENTRY RESPONSE Y2-Y9 commands when available.

It is up to the reader to merge the received DATA ENTRY RESPONSE data and optionally update the display as required. The session is ended after the VMC sends the final DATA ENTRY RESPONSE data (no SESSION COMPLETE command is required). Note that the VMC display will remain available to the reader for the amount of time requested in the previous DISPLAY REQUEST response.

If the data entry process is cancelled by the VMC for any reason, the VMC will send the DATA ENTRY RESPONSE with all data bytes (Y2-Y9) set to FFh. This will terminate the DATA ENTRY REQUEST and return the reader to the Enabled state.

For ease of command message processing, the Data Entry Data has been fixed at 8 characters (Y2-Y9). Unused bytes must be sent as 00h to pad out the entire command to byte Y9.

Reader (14H / 64H)	Data Entry Response (03H) Y1	Data Entry Data Y2-Y9
-----------------------	---------------------------------------	-----------------------------

Level 03 Readers (if option enabled)

Y1 : DATA ENTRY RESPONSE
The VMC is providing a DATA ENTRY RESPONSE to the reader.

Y2-Y9 : DATA ENTRY DATA
Data should be in ASCII, one character per byte. Data should be left justified (first character / key in Y2, second in Y3, etc.). The number of data bytes must equal eight (8) and unused data bytes must be sent as 00h.

If the data entry process is cancelled by the VMC for any reason, the VMC will send this message with all DATA ENTRY data bytes set to FFh.

Note: The reader must translate the VMC key information into the appropriate key needed for the application

Reader response:

No Data response

Note: If the reader has additional display information to send to the VMC following the DATA ENTRY RESPONSE, it should send it via a DISPLAY REQUEST response to one of the next POLL commands from the VMC.

7.4.16 REVALUE - Request (Level 02 / 03 Readers)

Revalue (15H / 65H)	Revalue Request (00H) Y1	Revalue Amount Y2-Y3
------------------------	-----------------------------------	--------------------------------

Level 02 / 03 Readers

- Y1 :** REVALUE REQUEST (Level 02 Readers)
A balance in the VMC account because coins or bills were accepted or some balance is left after a vend. With this command the VMC tries to transfer the balance to the payment media.
- Y2-Y3 :** Revalue amount - scaled.
The revalue amount should not exceed the revalue limit value given by the command REVALUE LIMIT REQUEST.

Revalue (15H / 65H)	Revalue Request (00H) Y1	Revalue Amount Y2-Y5
------------------------	-----------------------------------	--------------------------------

Level 03 (EXPANDED CURRENCY MODE) Readers

- Y1 :** REVALUE REQUEST (Level 03 Readers)
A balance in the VMC account because coins or bills were accepted or some balance is left after a vend. With this command the VMC tries to transfer the balance to the payment media.
- Y2-Y5 :** Revalue Amount - scaled.
The revalue amount should not exceed the revalue limit value given by the command REVALUE LIMIT REQUEST.

Reader response:

Revalue Approved (0DH) Z1

Level 02 / 03 Readers

- Z1 :** REVALUE APPROVED (Level 02 / 03 Readers)
A balance is in the VMC account because coins or bills were accepted or some balance is left after a vend. The VMC has issued a REVALUE REQUEST to the payment media reader to transfer the balance to the payment media. The payment media reader accepted the request and added its value to the payment media balance. The reader then responds with a REVALUE APPROVED, so the VMC may clear the account.

Revalue Denied (0EH) Z1

Level 02 Readers

Z1 : REVALUE DENIED (Level 02 / 03 Readers)
 A balance is in the VMC account because coins or bills were accepted or some balance is left after a vend. The VMC has issued a REVALUE REQUEST to the payment media reader to transfer the balance to the payment media. The payment media reader does not accept the request and responds with a REVALUE DENIED, so the VMC has to pay out change. It is a quite common situation if there is no payment media inserted at this moment.

7.4.17 REVALUE - Limit Request (Level 02 / 03 Readers)

Revalue (15H / 65H) Z1	Revalue Limit Request (01H) Y1
------------------------------	---

Level 02 / 03 Readers

Note: If revaluing, follow the BEGIN SESSION with this command.

Y1 : REVALUE LIMIT REQUEST (Level 02 Readers)
 In a configuration with a bill and/or coin acceptor and payment media reader connected to a VMC, the VMC must know the maximum amount the payment media reader eventually will accept by a REVALUE REQUEST. Especially if the bill acceptor accepts a wide range of bills. Otherwise the VMC may be confronted by the situation where it accepted a high value bill and is unable to pay back cash or revalue it to a payment media. (see also below)

Reader response:

Revalue Limit Amount (0FH) Z1	Revalue Limit Amount Z2-Z3
---	-------------------------------------

Level 02 / 03 (EXPANDED CURRENCY MODE disabled) Readers

Z1 : REVALUE LIMIT AMOUNT (Level 02 / 03 Readers)

The patron intends to revalue the payment media with a bill of some value. The VMC must know what kind of bills to accept, so it will issue a REVALUE LIMIT REQUEST to get the amount the payment media reader will accept. The payment media reader will respond with the scaled value, calculated with the maximum allowed payment media balance minus the current balance of the payment media. The payment media reader responds with REVALUE DENIED if there is no payment media available upon this request.

Z2-Z3 : Revalue limit value - scaled.

Reader response:

Revalue Limit Amount (0FH) Z1	Revalue Limit Amount Z2-Z5
---	-------------------------------------

Level 03 (EXPANDED CURRENCY MODE) Readers

Z1 : REVALUE LIMIT AMOUNT (Level 03 Readers)
The patron intends to revalue the payment media with a bill of some value. The VMC must know what kind of bills to accept, so it will issue a REVALUE LIMIT REQUEST to get the amount the payment media reader will accept. The payment media reader will respond with the scaled value, calculated with the maximum allowed payment media balance minus the current balance of the payment media. The payment media reader responds with REVALUE DENIED if there is no payment media available upon this request.

Z2-Z5 : Revalue Limit Value - scaled.

7.4.18 EXPANSION - Request ID

Expansion (17H / 67H)	Request ID (00H)	Manufacturer Code	Serial Number	Model Number	Software Version
	Y1	Y2-Y4	Y5-Y16	Y17-Y28	Y29-Y30

Y1 : REQUEST ID
The VMC is requesting payment media reader identification information. The information included above (Y2-Y30) provides the payment media reader with VMC identification information.

Y2-Y4 : Manufacturer Code - ASCII
Identification code for the equipment supplier. Currently defined

codes are listed in the EVA document entitled "The Data Transfer Standard EVA-DTS" document, the Audit Data Dictionary section, chapter 4, "Manufacturer Codes".

- Y5-Y16 :** Serial Number - ASCII
Factory assigned serial number.
- Y17-Y28 :** Model Number - ASCII
Manufacturer assigned model number.
- Y29-Y30 :** Software Version - packed BCD
Current software version.

Reader response:

Peripheral ID (09H)	Manufacture Code	Serial Number	Model Number	Software Version
Z1	Z2-Z4	Z5-Z16	Z17-Z28	Z29-Z30

Level 01 / 02 / 03 Readers (If VMC indicates Level 01 or 02)

Peripheral ID (09H)	Manufacture Code	Serial Number	Model Number	Software Version	Optional Feature Bits
Z1	Z2-Z4	Z5-Z16	Z17-Z28	Z29-Z30	Z31-Z34

Level 03 Readers (If VMC indicates Level 03)

See paragraph 7.4.4 for a detailed explanation of this response.

7.4.19 EXPANSION - Read User File (Level 02 Readers)

Obsolete Command – Do not use for new designs!! (Use EXPANSION - Diagnostics)

Expansion (17H / 67H)	Read User File (01H)	Number of User File
	Y1	Y2

Level 02 Readers

- Y1= READ USER FILE
The VMC request's the user file. The length of the file is variable with a

maximum length of 32 bytes. The contents of the data are defined by the VMC manufacturer. If the payment media reader does support this command it will respond with USER FILE DATA.

Y2= Number of User File.
The File identification number. The number and size of the data files are defined by the payment media reader manufacturer. The maximum number of user files are FFh.

Reader response:

User Data File (10H)	Number of User File	Length of User File	User Data
Z1	Z2	Z3	Z4-Zn

Z1 : USER FILE DATA (only level 02 readers)
The VMC requires user data and has issued a EXPANSION - READ USER FILE to the payment media reader.

Z2 : Number of User File.
The File identification number. The number and size of data files are defined by the payment media reader manufacturer. The maximum number of user files are FFh.

Z3 : Length of user file
The length of the user file. The maximum length of the user file is 32 bytes. If the user file don't exists the length will be set to 00h.

Z4-Zn : Data defined by the VMC manufacturer.

7.4.20 EXPANSION - Write User File (Level 02 Readers)

Obsolete Command – Do not use for new designs!! (Use EXPANSION - Diagnostics)

Expansion (17H / 67H)	Write User File (02H)	Number of User File	Length of User File	User Data
	Y1	Y2	Y3	Y4-Yn

Y1 : WRITE USER FILE
The VMC request's to write the user file. The length of the file is variable with a maximum length of 32 bytes. The contents of the data are defined by the VMC manufacturer. If the command is supported but the payment media reader is unable to write the payment media (writing problem or data too long) it will respond with MALFUNCTION/ERROR.

- Y2 :** Number of User File.
The File identification number. The number and size of data files are defined by the payment media reader manufacturer. The maximum number of user files are FFh.
- Y3 :** Length of user file
The length of the user file. The maximum length of the user file is 32 bytes.
- Y4-Yn :** Data defined by the VMC manufacturer.

Reader response:

No Data response

7.4.21 EXPANSION - Write Time/Date File (Level 02/03 readers)

Expansion (17H / 67H)	Write Time/ Date File (03H)	Time Date
	Y1	Y2-Y11

- Y1 :** WRITE TIME/DATE FILE
The VMC requests to write the Time/Date file.
- Y2- Y11:** Time/Date to synchronize the card reader real time clock. The date bytes are BCD encoded.
- Y2 = Years (Range: 00..99)
Y3 = Months (Range: 01..12)
Y4 = Days (Range: 01..31)
Y5 = Hours (Range: 00..23)
Y6 = Minutes (Range: 00..59)
Y7 = Seconds (Range: 00..59)
Y8 = Day of Week (Range: 01..07, Monday = 1..Sunday = 7)
Y9 = Week Number (Range: 01..53)
Y10 = Summertime (Range: 00..01, Summertime = 1)
Y11 = Holiday (Range: 00..01, Holiday = 1)

If any item of the time/date is not supported use FFH instead.

7.4.22 EXPANSION – Enable Options (Level 03 readers)

Expansion (17H / 67H)	Optional Feature Bit Enable (04H)	Optional Feature Bits
	Y1	Y2-Y5

Level 03 Readers

- Y1 :** OPTIONAL FEATURE BIT ENABLE
The VMC can enable which level 3 features it desires.
- Y2 - Y5:** Individual expanded feature bits as sent by reader in response to the 17H-00H EXPANSION REQUEST ID command. To enable a feature, a bit is set to one. Bits should be sent in descending order, i.e. bit 31 is sent first and bit 0 is sent last. **All features are disabled after a reset.**
- b0 - File Transport Layer supported
 - b1 - 0 = 16 bit monetary format, 1 = 32 bit monetary format
 - b2 – Enable multi currency / multi lingual
 - b3 – Enable negative vend
 - b4 - Enabledata entry
 - b5 – Enable “Always Idle” state
 - b6 to b31 not used (should be set to 0)
- Note: If 32 bit monetary format (b1) and or multi currency / multi lingual (b2) options are enabled, this condition will be known as **EXPANDED CURRENCY MODE** in the rest of the document.

7.4.23 EXPANSION – FTL REQ TO RCV

Expansion (17H / 67H)	FTL (FAH) Y1	REQ TO RCV Y2-Y6
--------------------------	--------------------	-------------------------

Level 03 Readers (if File Transport Layer option enabled)

The VMC is requesting to receive data from the reader whose destination address will always be 10H or 60H. Note that all FTL Commands / Responses are defined in Section 2.6.

- Y1 :** **FTL REQ TO RCV**
The VMC is requesting to receive data from the reader.
- Y2 :** **FTL Destination Address** (Reader = 10H / 60H as defined in Section 2.6.
- Y3 :** **FTL Source Address**
The source address of the command as defined in Section 2.6.
- Y4 :** **FTL File ID**
The type of information desired as defined in Section 2.6.
- Y5 :** **FTL Maximum Length**
The total number of blocks in the file as defined in Section 2.6.
- Y6 :** **FTL Control**
Data transfer control information as defined in Section 2.6.

Reader response:

Two responses are possible from the reader, either the SEND BLOCK (1DH) which transmits the initial (or only) part of the data or the RETRY / DENY (1CH). Note that the response can either be immediate or delayed.

FTL (1DH)	SEND BLOCK
SEND BLOCK	Information
Z1	Z2-Z34

- Z1 :** 1DH response which indicates SEND BLOCK
- Z2 :** Destination address of data as defined in Section 2.6
- Z3 :** Block # of data as defined in Section 2.6
- Z4-Z34:** Data (maximum of 31 bytes)

or

FTL (1CH)	RETRY / DENY
RETRY / DENY	Information
Z1	Z2-Z4

- Z1 :** 1CH response which indicates RETRY / DENY
- Z2 :** Destination address of response as defined in Section 2.6
- Z3 :** Source address of response (10H / 60H) as defined in Section 2.6
- Z4 :** Retry delay

7.4.24 EXPANSION – FTL RETRY / DENY

Expansion (17H)	FTL (FBH)	RETRY / DENY
	Y1	Y2-Y4

Level 03 Readers (if File Transport Layer option enabled)

The VMC is retrying, denying, or aborting a data transfer to/from the reader whose destination address will always be 10H or 60H. Note that all FTL Commands / Responses are defined in Section 2.6.

- Y1 :** **FTL RETRY / DENY**
The VMC is requesting to retry, deny, or abort a data transfer.
- Y2 :** **FTL Destination Address (Reader = 10H / 60H)**
The destination address of the command as defined in Section 2.6.
- Y3 :** **FTL Source Address**

The source address of the command as defined in Section 2.6.

- Y4 :** **FTL Retry Delay**
The time delay required of the sender as defined in Section 2.6.

Reader response:

None

7.4.25 EXPANSION – FTL SEND BLOCK

Expansion (17H / 67H)	FTL (FCH) Y1	SEND BLOCK Y2-Y34
--------------------------	--------------------	----------------------

Level 03 Readers (if File Transport Layer option enabled)

The VMC is sending data to the reader whose destination address will always be 10H or 60H. Note that all FTL Commands / Responses are defined in Section 2.6.

- Y1 :** **FTL SEND BLOCK**
The VMC is requesting to send data.
- Y2 :** **FTL Destination Address (Reader = 10H / 60H)**
The destination address of the command / data as defined in Section 2.6.
- Y3 :** **FTL Block #**
The block # of data as defined in Section 2.6
- Y4-Y34** **FTL Data (maximum of 31 bytes)**
The actual data block as defined in Section 2.6.

Reader response:

None

7.4.26 EXPANSION – FTL OK TO SEND

Expansion (17H / 67H)	FTL (FDH) Y1	OK TO SEND Y2-Y3
--------------------------	--------------------	---------------------

Level 03 Readers (if File Transport Layer option enabled)

The VMC is indicating that it is OK for the reader to transfer data. The destination address will always be the reader 10H or 60H. Note that all FTL Commands / Responses are defined in Section 2.6.

- Y1 :** **FTL OK TO SEND**
The VMC is indicating it is OK to send data.

- Y2 :** **FTL Destination Address (Reader = 10H / 60H)**
The destination address of the command / data as defined in Section 2.6.
- Y3 :** **FTL Source Address**
The source address of the command as defined in Section 2.6.

Reader response:

One response is possible from the reader which transmits the initial (or only) part of the data. Note that the response can either be immediate or delayed.

FTL (1DH) SEND BLOCK Z1	SEND BLOCK Information Z2-Z34
----------------------------------	-------------------------------------

- Z1 :** 1DH response which indicates SEND BLOCK
- Z2 :** Destination address of data as defined in Section 2.6
- Z3 :** Block # of data as defined in Section 2.6
- Z4-Z34:** Data (maximum of 31 bytes)

7.4.27 EXPANSION – FTL REQ TO SEND

Expansion (17H / 67H)	FTL (FEH) Y1	REQ TO SEND Y2-Y6
--------------------------	--------------------	----------------------

Level 03 Readers (if File Transport Layer option enabled)

The VMC is requesting to send data to the reader whose destination address will always be 10H or 60H. Note that all FTL Commands / Responses are defined in Section 2.6.

- Y1 :** **FTL REQ TO SEND**
The VMC is requesting to send data to the reader.
- Y2 :** **FTL Destination Address (Reader = 10H / 60H)**
The destination address of the command as defined in Section 2.6.
- Y3 :** **FTL Source Address**
The source address of the command as defined in Section 2.6.
- Y4 :** **FTL File ID**
The type of information desired as defined in Section 2.6.
- Y5 :** **FTL Maximum Length**
The total number of blocks in the file as defined in Section 2.6.

- Y6 :** **FTL Control**
Data transfer control information as defined in Section 2.6.

Reader response:

Two responses are possible from the reader, either the OK TO SEND (1EH) which allows the data transfer to start or the RETRY / DENY (1CH). Note that the response can either be immediate or delayed.

FTL (1EH) OK TO SEND Z1	OK TO SEND Information Z2-Z3
-------------------------------	------------------------------------

- Z1 :** 1EH response which indicates OK TO SEND
Z2 : Destination address of response as defined in Section 2.6
Z3 : Source address of response (10H / 60H) as defined in Section 2.6

or

FTL (1CH) RETRY / DENY Z1	RETRY / DENY Information Z2-Z4
---------------------------------	--------------------------------------

- Z1 :** 1CH response which indicates RETRY / DENY
Z2 : Destination address of response as defined in Section 2.6
Z3 : Source address of response (10H / 60H) as defined in Section 2.6
Z4 : Retry delay

7.4.28 EXPANSION - Diagnostics

Expansion (17H / 67H)	Diagnostics (FFH) Y1	User Defined Data Y2-Yn
--------------------------	----------------------------	----------------------------------

- Y1 :** DIAGNOSTICS.
Device manufacturer specific instruction for implementing various manufacturing or test modes.

- Y2-Yn :** User Defined Data.

The data portion of this command is defined by the manufacturer and is not part of this document.

Reader response:

Diagnostics Response (FFH) Z1	User Defined Z2-Zn
----------------------------------	-----------------------

Z1 : DIAGNOSTICS RESPONSE

Z2-Zn : User Defined Data.
The data portion of this response is defined by the manufacturer and is not part of this document.

7.5 Cashless Device Non-Response Time

The default maximum non-response time for a cashless device is 5 seconds. This is the maximum time for which a cashless device will not respond to a command or a POLL with ACK, NAK or a message. The “Application Maximum Response Time” reported in byte Z7 of the Reader Configuration Data (7.4.2) supersedes this default value if Z7 is greater.

Unless otherwise specified, a VMC should also use this value as a timeout for a response to commands that require data to be returned. (See Section 7.3.)

7.6 Cashless Device Power Requirements

The current draw for any cashless device must fall within the following limits. All measurements are at the minimum VMC Voltage Output.

Idle mode = 300 mA. (avg.) continuous

Transport or Read/Write cycle = 1.5 A @ 50% maximum duty cycle up to 5 seconds.

7.7 Example Vend Sessions

EXAMPLE VEND SESSION #1 (Valid Single Vend)

Controller		Cashless Device	State
POLL	→		
	←	BEGIN SESSION	(Session Idle)
ACK	→		
VEND REQUEST	→		
	←	ACK	(Vend)
POLL	→		
	←	VEND APPROVED	
ACK	→		
VEND SUCCESS	→		
	←	ACK	(Session Idle)
SESSION COMPLETE	→		
	←	ACK	
POLL	→		
	←	END SESSION	(Enabled)
ACK	→		

EXAMPLE VEND SESSION #2
(Valid Multiple Vend)

Controller		Cashless Device	State
POLL	→		
	←	BEGIN SESSION	(Session Idle)
ACK	→		
VEND REQUEST	→		
	←	ACK	(Vend)
POLL	→		
	←	VEND APPROVED	
ACK	→		
VEND SUCCESS	→		
	←	ACK	(Session Idle)
VEND REQUEST	→		
	←	ACK	(Vend)
POLL	→		
	←	VEND APPROVED	
ACK	→		
VEND SUCCESS	→		
	←	ACK	(Session Idle)
SESSION COMPLETE	→		
	←	ACK	
POLL	→		
	←	END SESSION	(Enabled)
ACK	→		

EXAMPLE VEND SESSION #3
(Session cancelled by user with reader return button)

Controller		Cashless Device	State
POLL	→		
	←	BEGIN SESSION	(Session Idle)
ACK	→		
User pushes reader RETURN button			
POLL	→		
	←	SESSION CANCEL	
ACK	→		
SESSION COMPLETE	→		
	←	ACK	
POLL	→		
	←	END SESSION	(Enabled)
ACK	→		

EXAMPLE VEND SESSION #4a
(Session cancelled by user via coin mechanism
escrow return button before product was selected)

Controller		Cashless Device	State
POLL	→		
	←	BEGIN SESSION	(Session Idle)
ACK	→		
User pushes coin mech. escrow return			
SESSION COMPLETE	→		
	←	ACK	
POLL	→		
	←	END SESSION	(Enabled)
ACK	→		

EXAMPLE VEND SESSION #4b
(Session cancelled by user via coin mechanism
escrow return button after product was selected)

Controller		Cashless Device	State
POLL	→		
	←	BEGIN SESSION	(Session Idle)
ACK	→		
VEND REQUEST	→		
	←	ACK	(Vend)
User pushes coin mech. escrow return			
CANCEL VEND	→		
	←	ACK	
POLL	→		
	←	VEND DENIED	(Session Idle)
SESSION COMPLETE	→		
	←	ACK	
POLL	→		
	←	END SESSION	(Enabled)
ACK	→		

EXAMPLE VEND SESSION #5
(VMC Failure/product not dispensed
Refund positive)

Controller		Cashless Device	State
POLL	→		
	←	BEGIN SESSION	(Session Idle)
ACK	→		
VEND REQUEST	→		
	←	ACK	(Vend)
Reader deducts purchase price from payment media			
POLL	→		
	←	VEND APPROVED	
VMC fails to dispense product			
VEND FAILURE	→		
	←	ACK	
POLL	→		
	←	Silence during the refund operation	
POLL	→		
	←	ACK	C
SESSION COMPLETE	→		
	←	ACK	
POLL	→		
	←	END SESSION	(Enabled)
ACK	→		

**EXAMPLE VEND SESSION #5A
(VMC Failure/product not dispensed
Refund fail)**

Controller		Cashless Device	State
POLL	→		
	←	BEGIN SESSION	(Session Idle)
ACK	→		
VEND REQUEST	→		
	←	ACK	(Vend)
Reader deducts purchase price from payment media			
POLL	→		
	←	VEND APPROVED	
VMC fails to dispense product			
VEND FAILURE	→		
	←	ACK	
POLL	→		
	←	Silence during the refund operation	
POLL	→		
	←	MALFUNCTION ERROR code 1100yyyy=refund fail ACK	(Level 02 / 03) (Level 01)
SESSION COMPLETE	→		
	←	ACK	
POLL	→		
	←	END SESSION	(Enabled)
ACK	→		

EXAMPLE VEND SESSION #6
(Vend denied by reader)

Controller		Cashless Device	State
POLL	→		
	←	BEGIN SESSION	(Session Idle)
ACK	→		
VEND REQUEST	→		
	←	ACK	(Vend)
Insufficient funds or payment media/account error			
POLL	→		
	←	VEND DENIED	(Session Idle)
VMC makes no attempt to dispense product			
SESSION COMPLETE	→		
	←	ACK	
POLL	→		
	←	END SESSION	(Enabled)
ACK	→		

EXAMPLE VEND SESSION #7
(Command Out of Sequence Error)

Controller		Cashless Device	State
POLL	→		
	←	BEGIN SESSION	(Session Idle)
ACK	→		
VEND REQUEST	→		
	←	ACK	(Vend)
EXPANSION ID REQUEST	→		
	←	ACK	
POLL	→		
	←	COMMAND OUT OF SEQUENCE	(Session Idle)
ACK	→		
RESET	→	{Mandatory}	
	←	ACK	
			(Inactive)

EXAMPLE VEND SESSION #8a
(Reader busy for longer than max. non response time)

Controller		Cashless Device	State
POLL	→		
	←	BEGIN SESSION	(Session Idle)
ACK	→		
VEND REQUEST	→		
	←	ACK	(Vend)
POLL	→		
		[silence...]	(Reader busy)
POLLs (numerous)	→		
	←	[silence...]	(continued POLLs w/ no response)
POLL	→		
	←	ACK	(restart Non-Response timer)
POLLs (numerous)	→		
	←	[silence...]	(continued POLLs w/ no response)
POLL	→		
	←	[silence...]	(Reader almost finished)
POLL	→		
	←	VEND APPROVED	(Reader ready)
ACK	→		
VEND SUCCESS	→		
	←	ACK	(Session Idle)
VEND REQUEST	→		
	←	ACK	(Vend)
POLL	→		
	←	VEND APPROVED	
ACK	→		
VEND SUCCESS	→		
	←	ACK	(Session Idle)
SESSION COMPLETE	→		
	←	ACK	
POLL	→		
	←	END SESSION	(Enabled)
ACK	→		

EXAMPLE VEND SESSION #8b
(Reader busy for shorter than max. non response time)

Controller		Cashless Device	State
POLL	→		
	←	BEGIN SESSION	(Session Idle)
ACK	→		
VEND REQUEST	→		
	←	ACK	(Vend)
POLL	→		
	←	[silence...]	(Reader busy)
POLLs (numerous)	→		
	←	[silence...]	(Continued POLLs w/ no response)
POLL	→		
	←	[silence...]	(Reader almost finished)
POLL	→		
	←	VEND APPROVED	(Reader ready)
ACK	→		
VEND SUCCESS	→		
	←	ACK	(Session Idle)
VEND REQUEST	→		
	←	ACK	(Vend)
POLL	→		
	←	VEND APPROVED	
ACK	→		
VEND SUCCESS	→		
	←	ACK	(Session Idle)
SESSION COMPLETE	→		
	←	ACK	
POLL	→		
	←	END SESSION	(Enabled)
ACK	→		

NOTE

If the peripheral omits to respond within the maximum non-response time, it is considered to be off-line.

EXAMPLE VEND SESSION #8c
(No Response, Reader busy at Vend Request.)

Controller		Cashless Device	State/ Comment
POLL	→		
	←	BEGIN SESSION	
ACK	→		
VEND REQUEST	→		
	←	[silence...]	Reader busy. The reader may not send the response within the t-response(max) timeout or hasn't received the command completely due to line breakdown
VEND REQUEST	→		VMC repeats the command: As the VMC isn't sure, that the slave has received the command free of errors it repeats it. The command itself is not yet performed by the reader as long the ACK hasn't been sent.
	←	[silence...]	Reader busy
VEND REQUEST	→		
	←	ACK	(Vend) The reader will now perform the command. The response isn't available at the moment, thus the VEND REQUEST is only acked
POLL (numerous)	→		VMC polls the reader to obtain the data in VEND APPROVED
	←	ACK	The reader may send a ACK or [silence] to each POLL
POLL	→		
	←	VEND APPROVED	The response to the VEND REQUEST is now available. It must be sent within the time defined by the APPLICATION MAXIMUM RESPONSE TIME. This is measured from the ACK following the VEND REQUEST.
ACK	→		

EXAMPLE VEND SESSION #9
(Pre-approved authorization aborted by coin
mechanism escrow return button before BEGIN SESSION)

Controller	Cashless Device	State
User swipes payment media		
		(Enabled)
POLL	→	
	←	ACK
READER CANCEL	→	
	←	ACK
(If applicable, reader aborts HOST communications, ejects payment media, etc...)		
POLL	→	
	←	CANCELLED
ACK	→	

**EXAMPLE VEND SESSION #10
(Single Negative Vend)**

Controller	Cashless Device	State
POLL	→	
	←	BEGIN SESSION (Session Idle)
ACK	→	
		User inserted a payment media, and inserted then a product, which was detected valid, or pressed a selection button to identify the desired product which will be inserted later on
NEGATIVE REQUEST	VEND →	
	←	ACK (Vend)
POLL	→	
	←	VEND APPROVED
		The payment reader is able to add the desired value to the credit
ACK	→	
		The product is now fully accepted from the machine or the user has finally finished insertion of a valid product
VEND SUCCESS	→	
	←	ACK (Session Idle)
		The payment media reader has added the credit
SESSION COMPLETE	→	
	←	ACK
POLL	→	
	←	END SESSION (Enabled)
ACK	→	

Normally, can or bottle return-vendors may check the product first, before the patron inserts his card. It is up to the VMC, to delay the negative vend request, until the session idle state is reached. In many return-vendors, from this state, the product is already fully accepted. Therefore, there is no need for the further sequences, this means, vend accepted, vend success will follow each other immediately.

If the payment media reader is not able to update the credit, there will be two conditions:

- The return vendor is able to escrow the product after the vend denied. In this case the session complete is sent, the product is return and the credit remains unchanged.
- The return vendor is not able to escrow the product after vend denied. In this case, session complete should be sent and there should be an update credit within the system (VMC), which could be returned by other means (i.e. return coins, tokens, etc).

If a return vendor is able to escrow the product again, this vendor normally accepts the product finally only a vend accepted was sent. In this case there may happen some fault condition which allows no final acceptance of the product. The return vendor then closes the session with vend failed instead of vend success, indicating to the reader not to update the system credit, or, if the payment media is no longer present, request re-insertion of the media.

EXAMPLE VEND SESSION #11
(Always Idle state option set)

Controller		Cashless Device	State
POLL	→		
	←	ACK	(Enabled)
VEND REQUEST	→		
	←	ACK	(Vend)
POLL	→		
	←	ACK	(repeated until User presents cashless media or timeout)
POLL	→		
	←	VEND APPROVED	
ACK	→		
VEND SUCCESS	→		
	←	ACK	(Session Idle)
SESSION COMPLETE	→		
	←	ACK	
POLL	→		
	←	END SESSION	(Enabled)
ACK	→		

EXAMPLE VEND SESSION CANCELLED #12
(Always Idle state option set)

Controller		Cashless Device	State
POLL	→		
	←	ACK	(Enabled)
VEND REQUEST	→		
	←	ACK	(Vend)
POLL	→		
	←	ACK	(repeated until User presents cashless media), but instead of this, cash is inserted

VEND CANCEL	→		
	←	ACK	(Session Idle)
POLL	→		
	←	VEND DENIED	(Session Idle)
SESSION COMPLETE	→		
	←	ACK	
POLL	→		
	←	END SESSION	(Enabled)
ACK	→		

EXAMPLE VEND SESSION TIMEOUT#13
(Always Idle state option set)

Controller		Cashless Device	State
POLL	→		
	←	ACK	(Enabled)
VEND REQUEST	→		
	←	ACK	(Vend)
POLL	→		
	←	ACK	(repeated until User presents cashless media or timeout), timeout occurs
POLL	→		
	←	VEND DENIED	
ACK	→		
SESSION COMPLETE	→		
	←	ACK	
POLL	→		
	←	END SESSION	(Enabled)
ACK	→		

EXAMPLE DATA ENTRY SESSION #1
(Three key Data Entry w/ Prompt & Asterisks for Entries)

Controller		Cashless Device	State
		Previously Enabled	Enabled
POLL	→		
	←	DATA ENTRY REQUEST + DISPLAY REQUEST (prompt)	
ACK	→		
		User pushes Selection Key 1	
DATA ENTRY RESPONSE (Key 1)	→		
	←	ACK	
POLL	→		
	←	DISPLAY REQUEST (prompt + *)	
ACK	→		
		User pushes Selection Key 2	
DATA ENTRY RESPONSE (Key 2)	→		
	←	ACK	
POLL	→		
	←	DISPLAY REQUEST (prompt + **)	
ACK	→		
		User pushes Selection Key 3	
DATA ENTRY RESPONSE (Key 3)	→		
	←	ACK	(Enabled)
POLL	→		
	←	DISPLAY REQUEST (prompt + *** or "Entry OK")	
ACK	→		
		Note: After Display Request Time expires, VMC regains control of display	
POLL	→		
	←	BEGIN SESSION	(Session Idle)
ACK	→		

**EXAMPLE DATA ENTRY SESSION #2
(Data Entry with Reader Cancel)**

Controller		Cashless Device	State
		Previously Enabled	Enabled
POLL	→		
	←	DATA ENTRY REQUEST + DISPLAY REQUEST (prompt)	
ACK	→		
		User pushes (valid) Selection Key	
DATA ENTRY RESPONSE (Key 1)	→		
	←	ACK	
POLL	→		
	←	DISPLAY REQUEST (prompt + *)	
ACK	→		
		User pushes (invalid) Selection Key	
DATA ENTRY RESPONSE (Key 2)	→		
	←	ACK	
POLL	→		
	←	DATA ENTRY CANCEL	
ACK	→		(Enabled)
POLL	→		
	←	DISPLAY REQUEST ("Error")	
ACK	→		
		After Display Request Time expires, VMC regains control of display	

Note that the above scenario is only an example and it may not be prudent to cancel a session after the first wrong entry. (Someone could fraudulently obtain a password by trying the maximum of selection keys at each position.)

**EXAMPLE DATA ENTRY SESSION #3
(Data Entry with VMC Cancel)**

Controller	Cashless Device	State
	Previously Enabled	Enabled
POLL	→	
	←	DATA ENTRY REQUEST + DISPLAY REQUEST (prompt)
ACK	→	
	User pushes Selection Key	
DATA ENTRY RESPONSE (Key 1)	→	
	←	ACK
POLL	→	
	←	DISPLAY REQUEST (prompt + *)
ACK	→	
	User walks away & VMC times out	
DATA ENTRY RESPONSE (FF's)	→	
	←	ACK (Enabled)
POLL	→	
	←	DISPLAY REQUEST ("Try Again")
ACK	→	
	After Display Request Time expires, VMC regains control of display	

Section 8

Communications Gateway

VMC/Peripheral Communication Specifications

8.1 Introduction

This section defines the communications bytes sent and received between a Communications Gateway (Comms Gateway) and the VMC. The Comms Gateway address is 00011xxxB (18H).

Unless otherwise stated, all information is assumed to be in a binary format.

After the VMC has issued a command, the Comms Gateway must respond with a reply. The reply may be an ACK or a detailed message response. If the command format expects a response, the Comms Gateway may: 1) respond with an ACK, to acknowledge receiving the command, and send the response later as a response to a POLL, or 2) immediately respond with the expected message.

The Comms Gateway response to a command from the VMC may be an ACK, a single message, or if there is more data to send it may be a multi message reply, up to the MDB maximum of 36 bytes.

The following command / response set has been defined to provide a means to transfer vending information system data from the VMC to the Comms Gateway in one of two ways;

- 1) Entire DTS files (including DXS, ST, SD1, G85, SE, and DXE records) are transferred using the file transport layer (FTL) of MDB.
- 2) Activity "Reports" are sent from the VMC to the Comms Gateway every time something happens in the vending system, it is then the Comms Gateways responsibility to store and assemble the DTS file. (DXS, ST, SD1, G85, SE and DXE data are not sent.) Obviously, a combination of these two methods can be designed to meet specific needs also.

8.2 VMC Commands

VMC Cmd	Code	VMC Data	Comm Gateway response
RESET	18H		00H - Just RESET (1)
SETUP	19H	Feature level (1) Scale factor (1) Decimal places (1)	01H - Comms Gateway Config (1) Feature level (1) Max. App. Resp. (2)
POLL	1AH		00H - Just RESET (1)
			01H - Comms Gateway Config (1) Feature level (1) Max. App. Resp. (2)
			02H - Request transmit (1)
			03H - Data transmitted (1)
			04H - Error (1) Error code (n)
			05H - DTS Event Acknowledge (1)
			06H - Peripheral ID: (1) Mfg. code (3) Serial number (12) Model number (12) Software ver. (2) Opt. features (4)
			07H - Radio Signal Strength (2)
			1BH - FTL REQ to RCV (option) (1)
			1CH - FTL RETRY / DENY (option) (1)
			1DH - FTL SEND BLOCK (option) (1)
			1EH - FTL OK to SEND (option) (1)
			1FH - FTL REQ to SEND (option) (1)
			FFH - Diagnostics (n)
REPORT	1BH	Type = 01, Transaction (1) Transaction Type (1) Selection (Row/Col.) (2) Price (2) Cash in, Coin tubes (2) Cash in, Cashbox (2) Cash in, Bills (2) Value in, Cashless #1 (2) Value in, Cashless #2 (2) Revalue to Cashless #1 (2) Revalue to Cashless #2 (2) Cash out (2) Discount Amount (2) Surcharge Amount (2) User Group # (1) Price List (1) Date (4) Time (2)	

		Type = 02, DTS Event (1) DTS Event Code (10) Date (4) Time (2) Duration (4) Activity (1) Terminal ID (12)	05-DTS Event Acknowledge (1)
		Type = 03, Asset ID (1) Asset Type = 0n (1) Manufacture Code (3) Serial Number (12) Model Number (12) Software Version (2)	
		Type = 03, Asset ID (1) Asset Type = 8n (1) Asset Number (20)	
		Type = 04, Currency ID (1) VMC Currency Code (2) VMC Currency (1) VMC Decimal Point (1)	
		Type = 05, Product ID (1) Product Identification (20) Selection Presence (1)	
CONTROL	1CH	00H - Disable (1)	
		01H - Enable (1)	
		02H - Transmit (1)	
EXPANSION	1FH	00H - Identification	06H - Peripheral ID: (1) Mfg. code (3) Serial number (12) Model number (12) Software ver. (2) Opt. features (4)
		01H - Feature enable (1) Features enabled (4)	
		02H - Time/Date Request (1) Time/Date (1)	07H - CG Time/Date (1) Years (1) Months (1) Days (1) Hours (1) Minutes (1) Seconds (1) Day of Week (1) Summertime (1) Holiday (1)
		FAH - FTL (option) REQ TO RCV	1DH - SEND BLOCK 1CH - RETRY / DENY
		FBH - FTL (option) RETRY / DENY	No Data
		FCH - FTL (option) SEND BLOCK	No Data

	FDH - FTL (option) OK TO SEND	1DH - SEND BLOCK
	FEH - FTL (option) REQ TO SEND	1EH - OK TO SEND 1CH - RETRY/DENY
	FFH - Diagnostics (n)	FFH - Diagnostics (n)

8.3 Communications Gateway Command Format

VMC Command	Code/Sub-code	VMC Data	Comms Gateway Response
RESET	18H	No data	None

This command is the vehicle that the VMC should use to tell the Comms Gateway that it should perform its initialization procedure. With the exception of the ACK response, it should abort all communication and revert to the internally stored operational parameters.

The following initialization sequence is recommended. It should be used after “power up”, after issuing the RESET command, or after issuing the Bus Reset (pulling the transmit line “active” for a minimum of 100 mS).

POLL – 18H

To obtain “JUST RESET” response

SETUP – 19H

To obtain Comms Gateway level and configuration information

EXPANSION IDENTIFICATION – 1F 00H

To obtain additional identification information and options

EXPANSION FEATURE ENABLE – 1F 01H

To enable desired options

CONTROL / ENABLE – 1CH / 01H

To enable / alert the Comms Gateway to start collecting data and / or monitoring for REPORT commands situations.

VMC Command	Code/Sub-code	VMC Data	Comms Gateway Response
SETUP	19H	Y1 - Y3	Z1 - Z4

Y1 = VMC feature level

Indicates the highest Comms Gateway feature level that the VMC supports. Currently the highest feature level is 03, with no requirement to support previous (obsolete) levels 1 and 2.)

Y2 = Scale factor

The multiplier used to scale all monetary values transferred between the VMC and the Comms Gateway.

Y3 = Decimal places

The number of decimal places used to communicate monetary values between the VMC and the Comms Gateway.

Z1 = 01 COMMS GATEWAY CONFIGURATION

The Comms Gateway is responding to a SETUP command. This response includes the following data;

Z2 = Comms Gateway feature level

The feature level of the Comms Gateway. Currently the highest feature level is 03, with no requirement to support previous (obsolete) levels 1 and 2.)

Z3 - Z4 = Application maximum response time

The maximum length of time, in seconds, that an Comms Gateway may be unable to respond to any commands. This includes the time communicating over an external network. The VMC should continue POLLing the Comms Gateway during this time in an attempt to re-synchronize communications earlier. When the Comms Gateway is ready to communicate over the bus again, it should respond to the next POLL with COMPLETE (if communicating externally) or ACK. This time essentially replaces the standard MDB non-response time, as such it's default value is equal to the defined non-response time (5 seconds).

VMC Command Code/Sub-code VMC Data Comms Gateway Response

POLL 1AH No data Z1 - Zn

The POLL command is used by the VMC to obtain information from the Comms Gateway. This information may include setup information, activity requests, or error conditions. An ACK response indicates that no error states exist and either no information request is pending or pending information is not yet ready for transmission.

In addition to an ACK, the VMC may receive the following POLL responses from the Comms Gateway.

- Z1 = 00 JUST RESET
- Indicates the Comms Gateway has been reset internally or on command from the VMC.
- Z1 = 01 COMMS GATEWAY CONFIGURATION
- The Comms Gateway is responding to a SETUP command. This response includes the following data;
- Z2 = Comms Gateway feature level
- The feature level of the Comms Gateway. Currently the highest feature level is 03, with no requirement to support previous (obsolete) levels 1 and 2.)
- Z3 - Z4 = Application maximum response time
- The maximum length of time, in seconds, that an Comms Gateway may be unable to respond to any commands. This includes the time communicating over an external network. The VMC should continue POLLing the Comms Gateway during this time in an attempt to re-synchronize communications earlier. When the Comms Gateway is ready to communicate over the bus again, it should respond to the next POLL with COMPLETE (if communicating externally) or ACK. This time essentially replaces the standard MDB non-response time, as such it's default value is equal to the defined non-response time (5 seconds).
- Z1 = 02 REQUEST TO TRANSMIT
- The Comms Gateway is requesting permission to transmit data to an external collection device. This is done to control the bus power supply. The Comms Gateway should continue sending this response to each POLL until permission to transmit has been granted or the need to transmit goes away.
- Z1 = 03 DATA TRANSMITTED
- The Comms Gateway is finished transmitting to an external collect device.
- Z1 = 04 ERROR
- The Comms Gateway has developed some type of detectable error. The error codes will be sent continuously, or until the error is resolved.
- Z2 – Zn = Error code
- The error codes are ASCII strings taken from the EVA DTS Communications fault list.

Z1 = 05 DTS EVENT ACKNOWLEDGE

The Comms Gateway has recognized that a DTS Event has occurred and must act accordingly. The specific actions will be defined by the Comms Gateway operational specifications.

Z1 = 06H PERIPHERAL ID

Comms Gateway is sending peripheral ID information. This response includes the following data;

Z2 - Z4 = Manufacturer code

Identification code for the equipment supplier. Sent as ASCII characters. Blanks (20H) are acceptable.

Z5 - Z16 = Serial number

Factory assigned serial number sent as numeric ASCII characters. All bytes must be sent. Zeros (30H) and blanks (20H) are acceptable.

Z17 - Z28 = Model number ASCII.

Manufacturer assigned model number sent as ASCII characters. All bytes must be sent. Zeros (30H) and blanks (20H) are acceptable.

Z29 - Z30 = Software version

Current software version sent as packed BCD.

Z31 - Z34 = Optional Features

Each of the 32 bits indicate an optional features availability. If the bit is set the feature is available. Currently defined options are:

b0: File transport layer support
 b1: Verbose mode: See REPORT command
 b2 : Expansion Time/Date Request command
 b3- b31: Future use, must be set to 0.

Z1 = 07H RADIO SIGNAL STRENGTH

The Comms Gateway is reporting its signal strength from the network. This response includes the following data;

Z2 = Signal Strength

The level of radio signal strength detected by the Comms Gateway. This is a binary number from 00H to 64H (100%) representing the percentage of expected signal. This can be sent after every POLL, or as needed due to changes in the signal.

Note that all FTL responses below are defined in Section 2.6. For the Comms Gateway, the source address will always be the Comms Gateway (18H) as defined in Section 2.3.

Z1 = 1BH REQ TO RCV (File Transport Layer)

The Comms Gateway is requesting to receive data from a device or VMC.

Z2 = Destination address of response

Z3 = Source address of response (18H)

Z4 = File ID

Z5 = Maximum length

Z6 = Control

Z1 = 1CH RETRY/DENY (File Transport Layer)

The Comms Gateway is requesting a device or VMC to retry or deny the last FTL command.

Z2 = Destination address of response

Z3 = Source address of response (18H)

Z4 = Retry delay

Z1 = 1DH SEND BLOCK (File Transport Layer)

The Comms Gateway is sending a block of data (maximum of 31 bytes) to a device or VMC.

Z2 = Destination address of data

Z3 = Block #

Z4-Z34 = Data (maximum of 31 bytes)

Z1 = 1EH OK TO SEND (File Transport Layer)

The Comms Gateway is indicating that it is OK for a device or VMC to send it data.

Z2 = Destination address of response

Z3 = Source address of response (18H)

Z1 = 1F REQ TO SEND (File Transport Layer)

The Comms Gateway is requesting to send data to a device or VMC.

- Z2 = Destination address of response
- Z3 = Source address of response (18H)
- Z4 = File ID
- Z5 = Maximum length
- Z6 = Control

Z1 = FFH DIAGNOSTICS

The Comms Gateway is responding to a EXPANSION/DIAGNOSTICS command. This response includes the following data;

Z2 - Zn User defined data

Device manufacturer specific responses after receiving manufacturing or test instructions. Z1 - Zn implies that any number of bytes may be used for the response data from the Comms Gateway.

VMC Command Code/Sub-code VMC Data Comms Gateway Response

REPORT 1BH Y1 – Ynn No data

The REPORT command is used by the VMC to pass activity information to the Comms Gateway. If the “Verbose mode” is enabled via the EXPANSION / FEATURE ENABLE command, this command must be sent immediately following the completion of any activity it is describing. The activities may include; a transaction, a DTS defined event, an asset identification, currency identification, or product identification.

The intent of this command is to provide information so that the Comms Gateway can create a Data Transfer Standard file. All of the following fields show their corresponding DTS fields for reference, for further detail refer to the Data Transfer Standard.

If the “Verbose mode” is disabled, only the “DTS Event” report type records must be sent. This mode uses the FTL to transfer the complete DTS files and the DTS Event report types to alert the VMC of any alarm conditions.

Since reports data may vary, any field that is not relevant, or not known, should be populated with 00H’s. All cash values are scaled and decimal adjusted using the data provided in the SETUP command.

Y1 = Type: The type of activity that is being reported, includes one of the following:

01H	Transaction
02H	DTS Event
03H	Asset ID
04H	Currency ID
05H	Product ID

If Y1 = 01H then the following “Transaction” data fields have been identified to be included:

Y2 = Transaction Type

This field defines the type of transaction that the following data describes. The defined transaction types include;

01H	Paid Vend
02H	Token Vend
03H	Free Vend
04H	Test Vend
05H	Revalue
06H	Negative Vend
07H	Vendless*
08H	Manual / Service

* The end of a “Vendless” transaction is defined by the VMC manufacturer, for example an escrow request, a failed vend, etc.

Y3 – Y4 = Item Number

This is the binary field used to link REPORT type 01 to REPORT type 05. It is an item number, 0000H through FFFFH of the selected product involved in the most recent transaction. This number is defined by the manufacturer.

Y5 – Y6 = Price (PA102)

The established price of the product involved in the most recent transaction. The established price is the price before any adjustments i.e. discounts surcharges, etc.

Y7 – Y8 = Cash in, Coin Tubes (CA303/CA307 or CA1001/CA1002)

The value of cash deposited into the coin tubes since the completion of the previous transaction.

Y9 – Y10 =	Cash in, Cashbox	(CA302/CA306)
	The value of cash deposited into the cashbox since the completion of the previous transaction.	
Y11 – Y12 =	Cash in, Bills	(CA304/CA308)
	The value of cash deposited into the bill stacker since the completion of the previous transactions.	
Y13 – Y14 =	Value in, Cashless Device #1	(DA201/DA203)
	The value removed from the media in cashless device #1 since the completion of the previous transaction.	
Y15 – Y16 =	Value in, Cashless Device #2	(DB201/DB203)
	The value removed from the media in cashless device #2 since the completion of the previous transaction.	
Y17 – Y18 =	Revalue to Cashless Device #1	(DA401/DA402)
	The value returned to the media in cashless device #1 since the completion of the previous transaction.	
Y19 – Y20 =	Revalue to Cashless Device #2	(DB401/DB402)
	The value returned to the media in cashless device #2 since the completion of the previous transaction.	
Y21 – Y22 =	Cash out	(CA401/CA403 or CA402/CA404)
	The total value of the cash dispensed from the system since the completion of the previous transaction.	
Y23 – Y24 =	Discount Amount	(CA701/CA702)
	The value of any discounts awarded since the completion of the previous vend.	
Y25 – Y26 =	Surcharge Amount	(CA705/CA706)
	The value of any surcharges collected since the completion of the previous vend.	
Y27 =	User Group #	(DA701 or DB701)

The user group number that the transaction is associated with.

Y28 = Price List (LA101)

The price list that the transaction is associated with

Y29 – Y32 = Date (PA501)

The date of the transaction. This data is sent as BCD in the following sequence YYYY/MM/DD. For example, 17 March 2002 would be 20H 02H 03H 17H. If the date is not known these bytes are filled with 99Hs.

Y33 – Y34 = Time (PA502)

The time of the transaction. This data is sent as BCD , 24 hour format, in the following sequence HHMM. For example, 6:30 PM would be 18H 30H. If the time is not known these bytes are filled with 99Hs.

If Y1 = 02H then the following “DTS Event” data fields have been identified to be included:

Y2 – Y11 = DTS Event Code (EA101 or EA201 or EA701)

This is an alpha-numeric ASCII code defining the event being reported. The codes are list in the EVA DTS manual. In addition to the standard DTS event codes, an interrogation event is reported as “EA3” and a power outage event is reported as “EA7”.

Y12 – Y15 = Date (EA102)

The date of the event. This data is sent as BCD in the following sequence YYYY/MM/DD. For example, 17 March 2002 would be 20H 02H 03H 17H. If the date is not known these bytes are filled with 99Hs.

Y16 – Y17 = Time (EA103)

The time of the event. This data is sent as BCD in the following sequence HH/MM. For example, 6:30 PM would be 18H 30H. If the time is not known these bytes are filled with 99Hs.

Y18 – Y21 = Duration (EA206)

The duration of the event in total minutes. This data is sent as binary. For example, 4 hours and 15 minutes would be 00H 00H 00H FFH.

Y22 = Activity (EA205)

The current status of the events activity. This field is equal to 00H if the event is inactive (or not reset for “EA3”) or 01H if the event is active (or reset for “EA3”).

Z1 = 05 DTS EVENT ACKNOWLEDGE

The Comms Gateway has recognized that a possible alarm situation has occurred and must act accordingly. The specific actions will be defined by the Comms Gateway operational specifications.

If Y1 = 03H then the following “Asset ID” data fields have been identified to be included:

Y2 = Asset Type

The following code pairs have been defined to represent the type of equipment asset that is being communicated.

Code	Equipment type	DTS header (αα)
01H / 81H	Audit Module / Data Carrier (DC) Identification	AM1
02H / 82H	Bill Validator Identification	BA1
03H / 83H	Changer Identification	CA1
04H / 84H	Control Board Identification	CB1
05H / 85H	Cashless #1 Identification	DA1
06H / 86H	Cashless #2 Identification	DB1
07H / 87H	Machine Identification	ID1

If Y2 has the MSB = 0 (i.e. Y2 = 01H) then the following asset data fields have been identified to be included:

Y3 – Y5 = Manufacturer code (αα101, first 3 characters)

Identification code for the equipment supplier. Sent as ASCII characters. Blanks (20H) are acceptable.

Y6 - Y17 = Serial number (αα101, 4th through 15th characters)

Factory assigned serial number sent as numeric ASCII characters. All bytes must be sent. Zeros (30H) and blanks (20H) are acceptable.

Y18 - Y29 = Model number (αα102)

Manufacturer assigned model number sent as ASCII characters. All bytes must be sent. Zeros (30H) and blanks (20H) are acceptable.

Y30 - Y31 = Software version (or Build Standard) (αα103)

Current software version sent as packed BCD.

If Y2 has the MSB = 1 (i.e. Y2 = 81H) then the following asset data fields have been identified to be included:

Y2 – Y21 = Asset Number (αα105 or αα106)

The asset number of the equipment. This is a reference number used for tracking purposes, separate from the serial number. It is usually programmed by the equipment operator.

If Y1 = 04H then the following “Currency ID” data fields have been identified to be included:

Y2 – Y3 = VMC’s Country / Currency Code (ID402)

The packed BCD Country / Currency code of the VMC can be sent in two different forms depending on the value of the left most BCD digit.

If the left most digit is a 0, the International Telephone Code is used to indicate the country that the changer is set-up for. For example, the USA code is 00 01H (Z2 = 00 and Z3 = 01).

If the left most digit is a 1, the latest version of the ISO 4217 numeric currency code is used. For example, the code for the US dollar is 18 40H (Z2 = 18 and Z3 = 40) and for the Euro is 19 78 (Z2 = 19 and Z3 = 78).

All new designs after July, 2000 must use the ISO 4217 numeric currency codes.

Y4 = VMC’s Coin Scaling Factor / Currency Description (ID403)

The multiplier used to scale all monetary values transferred between the VMC and the vending machines monetary system.

Y5 = VMC’s Decimal Point (ID401)

The number of digits to the right of the decimal point. This field is used in countries whose currency requires a number of digits to the right of the decimal point other than 2.

If Y1 = 05H then the following “Product ID” data fields have been identified to be included:

Y2 – Y3 = Item Number

Permission to transmit and / or receive data is granted, or a transmission session is requested. A DATA TRANSMITTED response to a POLL must be sent when the transmission session is complete.

VMC Command	Code/Sub-code	VMC Data	Comms Gateway Response
EXPANSION/ IDENTIFICATION	1FH/00H	Y1	Z1 - Z34

Y1 = 00H IDENTIFICATION subcommand

The VMC is requesting Comms Gateway identification information for asset tracking and optional feature purposes.

Z1 = 06H PERIPHERAL ID

Comms Gateway is sending peripheral ID information. This response includes the following data;

Z2 - Z4 = Manufacturer code

Identification code for the equipment supplier. Sent as ASCII characters. Blanks (20H) are acceptable.

Z5 - Z16 = Serial number

Factory assigned serial number sent as numeric ASCII characters. All bytes must be sent. Zeros (30H) and blanks (20H) are acceptable.

Z17 - Z28 = Model number ASCII.

Manufacturer assigned model number sent as ASCII characters. All bytes must be sent. Zeros (30H) and blanks (20H) are acceptable.

Z29 - Z30 = Software version

Current software version sent as packed BCD.

Z31 - Z34 = Optional Features

Each of the 32 bits indicate an optional features availability. If the bit is set the feature is available. Currently defined options include:

b0: File transport layer support.
 b1: Verbose mode: See REPORT command
 b2 - b31: Future use, must be set to 0.

VMC Command	Code/Sub-code	VMC Data	Comms Gateway Response
EXPANSION/ FEATURE ENABLE	1FH/01H	Y1 - Y5	No data

Y1 = 01H FEATURE ENABLE subcommand

This command is used to enable each of the optional features defined in Z32-Z35 of the PERIPHERAL ID response. The VMC should send the EXPANSION /IDENTIFICATION command, receive the PERIPHERAL ID response, perform a logical OR with the optional features it wants to enable, and return the resulting enabled features back to the Comms Gateway by setting a bit to 1 for each respective optional feature enabled. All optional features are disabled after reset.

Y2 - Y5 = Optional features enabled

Each of the 32 bits indicates an optional features state. If the bit is set the feature is enabled.

VMC Command	Code/Sub-code	VMC Data	Comms Gateway Response
EXPANSION/ TIME/DATE REQUEST	1FH/02H	Y1	Z1-Z11

Y1 = 01H TIME/DATE subcommand

Normally the Comms Gateway is a networked device, and therefore capable of asking the actual time from a server if required. This command is used to synchronize the VMC's real time clock from the Comms Gateway.

To be able to use the command it must be enabled via the EXPANSION / FEATURE ENABLE command.

Z1 = 01H CG Time/Date

The date bytes are BCD encoded

Z2 = Years (Range: 00..99)

Z3 = Months (Range: 01..12)

Z4 = Days (Range: 01..31)

Z5 = Hours (Range: 00..23)

Z6 = Minutes (Range: 00..59)

Z7 = Seconds (Range: 00..59)

Z8 = Day of Week (Range: 01..07, Monday = 1..Sunday = 7)

- Z9 = Week Number (Range: 01..53)
- Z10 = Summertime (Range: 00..01, Summertime = 1)
- Z11 = Holiday (Range: 00..01, Holiday = 1)

If any item of the time/date is not supported use FFH instead

VMC Command	Code/Sub-code	VMC Data	Comms Gateway Response
EXPANSION COMMAND	0FH FAH FTL REQ TO RCV	Y1-Y5	Z1 - Zn (immediate or POLLed)

The VMC is requesting to receive data from the Comms Gateway whose destination address will always be (18H). Note that all FTL Commands / Responses are defined in Section 2.6.

- Y1 = Destination address of command (18H)
- Y2 = Source address of command
- Y3 = File ID
- Y4 = Maximum length
- Y5 = Control

- Z1 = 1DH which indicates SEND BLOCK
- Z2 = Destination address of data
- Z3 = Block #
- Z4 - Z34 = Data (maximum of 31 bytes)
- or
- Z1 = 1CH which indicates RETRY / DENY
- Z2 = Destination address of response
- Z3 = Source address of response (18H)
- Z4 = Retry delay

VMC Command	Code/Sub-code	VMC Data	Comms Gateway Response
EXPANSION COMMAND	0FH FBH FTL RETRY / DENY	Y1-Y3	None

The VMC is retrying, denying, or aborting a data transfer to/from the Comms Gateway whose destination address will always be (18H). Note that all FTL Commands / Responses are defined in Section 2.6.

Y1 =	Destination address of command (18H)
Y2 =	Source address of command
Y3 =	Retry delay

VMC Command	Code/Sub-code	VMC Data	Comms Gateway Response
EXPANSION COMMAND	0FH FCH FTL SEND BLOCK	Y1-Y33	None

The VMC is sending data to the Comms Gateway whose destination address will always be (18H). Note that all FTL Commands / Responses are defined in Section 2.6.

Y1 =	Destination address of command & data (18H)
Y2 =	Block #
Y3 - Y33 =	Data (maximum of 31 bytes)

VMC Command	Code/Sub-code	VMC Data	Comms Gateway Response
EXPANSION COMMAND	0FH FDH FTL OK TO SEND	Y1-Y2	Z1-Z34 (immediate or POLLed)

The VMC is indicating that it is OK for the Comms Gateway to transfer data. The destination address will always be the Comms Gateway (18H). Note that all FTL Commands / Responses are defined in Section 2.6.

Y1 =	Destination address of command (18H)
Y2 =	Source address of command
Z1 =	1DH which indicates SEND BLOCK
Z2 =	Destination address of data
Z3 =	Source address of data
Z4 - Z34 =	Data (maximum of 31 bytes)

VMC Command	Code/Sub-code	VMC Data	Comms Gateway Response
EXPANSION COMMAND	0FH FEH FTL REQ TO SEND	Y1-Y5	Z1 - Zn (immediate or POLLed)

The VMC is requesting to send data to the Comms Gateway whose destination address will always be (18H). Note that all FTL Commands / Responses are defined in Section 2.6.

- Y1 = Destination address of command (18H)
- Y2 = Source address of command
- Y3 = File ID
- Y4 = Maximum length
- Y5 = Control

- Z1 = 1EH which indicates OK TO SEND
- Z2 = Destination address of response
- Z3 = Source address of response (18H)
or
- Z1 = 1CH which indicates RETRY / DENY
- Z2 = Destination address of response
- Z3 = Source address of response (18H)
- Z4 = Retry delay

VMC Command	Code/Sub-code	VMC Data	Comms Gateway Response
EXPANSION/ DIAGNOSTICS	1FH/FFH	Y1 - Yn	Z1 - Zn

- Y1 = FFH DIAGNOSTICS subcommand

Device manufacturer specific instruction for implementing various manufacturing or test modes.
- Y2 - Yn = User defined data

The data portion of this command is defined by the manufacturer and is not part of this document.
- Z1 = FFH DIAGNOSTICS

The Comms Gateway is responding to a EXPANSION/DIAGNOSTICS command. This response includes the following data;
- Z2 - Zn = User defined data

Device manufacturer specific responses after receiving manufacturing or test instructions. Z1 - Zn implies that any number of bytes may be used for the response data from the Comms Gateway.

8.4 Communications Gateway Non-Response Time

The maximum non-response time for a Comms Gateway is 5 seconds. This is the maximum time for which a Comms Gateway will not respond to a command with ACK, NAK, or a data message.

8.5 Communications Gateway Power Requirements

The current draw for any Comms Gateway must fall within the following limits. All measurements are at the minimum VMC Voltage Output.

Idle mode = 300 mA. (avg.) continuous

Active mode = 1.8 A continuous and up to 2.5 A (max) for an accumulated maximum of 10 seconds. The active power mode must be initiated by the REQUEST TO TRANSMIT followed by the CONTROL/TRANSMIT. The active power mode must be closed by sending the DATA TRANSMITTED. During this time the VMC will make its own decisions about which other peripherals will be disabled or not. This may result in the entire machine being disabled for normal vending.

8.6 Communications Gateway Examples

Event	Exchange
Power on Reset at VMC or JUST RESET received by VMC any other time	Reset sequence Enable sequence
Communications Gateway is triggered to send a file	Request sequence Transmit sequence
VMC is triggered to send a file	Dump sequence Transmit sequence
DTS Event situation occurs at VMC	DTS Event sequence Request sequence Transmit sequence
Error situation is detected at Comms Gateway	Error sequence
Every vend completion	Vend sequence

Reset sequence		
VMC	Comms Gateway	Comments
RESET (18)	→	Reset command
	← ACK	
POLL (1A)	→	Must be sent once reset, internal or external
ACK	← JUST RESET (00)	
SETUP (19...)	→	Establish operation configuration
ACK	← CONFIG. (01...)	
EXPANSION/ID (1F/00...)	→	Send asset information
	← PERIPHERAL ID (06...)	Get asset information
ACK	→	
EXPANSION/FEATURE ENABLE (1F/01...)	→	Enable additional feature if necessary
	← ACK	
Enable sequence		
VMC	Comms Gateway	Comments
CONTROL/ENABLE (1C01)	→	Enable command
	← ACK	
Disable sequence		
VMC	Comms Gateway	Comments
CONTROL/DISABLE (1C00)	→	Disable command
	← ACK	

Request sequence		
VMC	Comms Gateway	Comments
File transfer done	using the MDB	file transport layer
Dump sequence		
VMC	Comms Gateway	Comments
File transfer done	using the MDB	file transport layer
Transmit sequence		
VMC	Comms Gateway	Comments
POLL (1A)	→	
	←	Request to transmit (02)
ACK	→	
CONTROL/ TRANSMIT (1C/02)	→	
	←	ACK
POLL (1A)		
	ACK	
	.	Continue POLLing until ...
	.	
POLL (1A)	→	
	←	Data transmitted (03)
ACK	→	
DTS Event sequence		
VMC	Comms Gateway	Comments
REPORT (1B / 02...)	→	
	←	ACK
	.	Repeat until recognized
	.	
REPORT (1B /02...)	→	
	←	DTS EVENT ACKNOWLEDGE (05)
Error sequence		
VMC	Comms Gateway	Comments
POLL (1A)	→	
	←	ERROR (06)
ACK	→	Sent continuously, or until the error is resolved
Activity sequence		
VMC	Comms Gateway	Comments
REPORT (1B...)	→	
	←	ACK

Section 9

Universal Satellite Device (USD) VMC/Peripheral Communication Specifications

9.1 Introduction

An MDB Universal Satellite Device (USD) is a vending device which lacks customary credit acceptance peripherals. As such, a USD must rely on a host vending machine controller (VMC) to establish credit sufficient to perform a vend. The specification herein describes a protocol by which a USD and a VMC exchange messages and credit via the MDB bus.

9.1.1 Definitions

This section defines the non-response and application response time, base addresses, and the communication bytes sent by the MDB Universal Satellite Device (USD) and a Vending Machine Controller.

- The default maximum non-response time of the USD is 5 seconds.
- The default maximum application response time of the USD is 5 seconds.
- Three consecutive USD base addresses are defined to allow multiple USDs to operate simultaneously from a single VMC
- As defined in Section 2.3, the USD Base addresses are as follows: 01000xxxB (40H), 01001xxxB (48H), and 01010xxxB (50H).
- The specification defined herein assumes a USD base address of 40H in all examples. It should be understood that differing USD base addresses (48H and 50H) will follow the same command format.
- Multi-message responses to a single command are supported. Message length is subject to the 36 byte limit imposed by the MDB standard.
- Unless stated otherwise, all byte information contained herein is assumed to be in a binary format.
- Y_n represents bytes transmitted by the VMC, and Z_n are bytes transmitted by the USD.
- When words are referenced, they consist of two bytes with the higher order byte first.

	High		Low			
word =	b15	...	b8	b7	...	b0

9.2 USD Summary

This section is a summary of the USD command set and an overview of the modes of operation.

9.2.1 Command Summary

Command	Hex Code	Description
RESET	40	Command for USD to self-reset.
SETUP	41	Command to configure USD to VMC requirements.
POLL	42	Command to request for USD activity status.
VEND	43	Command for vend approve / deny.
FUNDS	44	Command to send funds available or to set prices.
CONTROL	45	Command to enable/disable USD.
EXPANSION	47	Command to allow addition of features and enhancements.

9.2.2 Overview

The USD Command set described herein allows USDs' to be controlled under the following three modes of operation. The USD's mode of operation is determined by the USD's configuration byte¹ and the sequence of commands the VMC uses.

- Mode One** VMC is used to select items to be vended from the USD and the VMC contains all pricing information. The USD receives vend requests from the VMC and reports vend success or failure.
- Mode Two** The USD or the VMC may select items to be vended. The USD may have special requirements for price and/or selection ID display. In this case, the USD may issue a **FUNDS** request to retrieve this information. The USD must then issue a **VEND** request to gain approval from the VMC before a vend can take place.
- Mode Three** The USD selects items to be vended and has its own pricing information. The USD must issue an vend request to the VMC and gain approval before a vend can take place.

¹ Configuration byte refers to byte Z31 of the sequence Z31 through Z34 of the expansion 07 command. Please refer to page 9.12 for more information on how this byte influences the USD's mode of operation.

9.3 Command Protocol

This section contains the complete command set relating to the USD.

9.3.1 RESET

Command	Code	VMC Data	USD Response data
RESET	40	No data bytes.	ACK

The **RESET** command is the vehicle that the VMC should use to instruct the USD to return to its default (power on) operating mode. The USD should respond to a reset command with an ACK to acknowledge receipt of the reset command. The USD must not accept any vend requests until the VMC issued setup command sequence has been completed.

The USD must also respond to the VMC issued “master reset” which resets all MDB peripheral devices. The VMC causes a master reset by transmitting a continuous break condition for a minimum of 100 milliseconds.

To ensure proper initialization, the USD should issue a “just reset” (see **POLL** response **00**) whenever it’s pricing or configuration has changed.

9.3.2 SETUP

Command	Code	VMC Data	USD Response Data
SETUP	41	5 bytes: Y1-Y5	7 bytes: 04 + Z1 - Z6

The **SETUP** command is the vehicle that the VMC should use to configure the USD for feature level, credit scaling factor, display decimal place, and maximum vend approve/deny time. The USD responds to this command by returning it’s feature level, highest vend price (divided by the scaling factor), selection configuration, and maximum application response time.

Alternatively, if the USD is not prepared to render a full response to the **SETUP** command, it may reply with an ACK. If this occurs, the USD must transmit it’s setup data later, in response to a **POLL** command (see **POLL** command, response **04**). Until the **SETUP** command has been received by the USD, and the USD has correspondingly returned it’s own setup data to the VMC, all vend requests will be disallowed.

Data sequence transmitted by the VMC to the USD during SETUP

VMC Data	Meaning or interpretation
----------	---------------------------

Y1 =	VMC Feature level, Indicates current feature level of the VMC. Currently defined level is one. ²
Y2 - Y3 =	Scaling factor 2 bytes (word). All transactions with the USD must be evenly divisible by this number.
Y4 =	Decimal place (02=US). Indicates the position of the decimal place on the USD's optional credit display
Y5 =	VMC maximum approve / deny time in seconds, FF = 255 seconds.

Data sequence transmitted by the USD to the VMC during SETUP

USD Response	Meaning or interpretation
04 + Z1 =	USD Feature level, indicates current feature level of the USD. Currently defined level is one. ³
Z2 - Z3 =	Maximum price on USD in 2 bytes (word). Indicates the highest priced item on the USD. ⁴ USD should return FF FFh if it does not have internal pricing capability.
Z4 - Z5 =	Item number, defined by the manufacturer configuration (Binary).
Z6 =	USD maximum application response time in seconds, FF = 255 seconds.

² Feature level of the VMC is sent to allow the USD to arbitrate command compatibility with the VMC.

³ Feature level of the USD is sent to allow the VMC to arbitrate command compatibility with the USD. The USD may opt to send this data later in response to a POLL.

⁴ The maximum price on the USD is returned to the VMC so this price can be used in the computation of maximum credit acceptance.

9.3.3 POLL

Command	Code	USD response Data	USD Response Description
POLL	42	00	USD has just been reset, or wishes to be reset by the VMC.
		01 + 4 bytes Z1- Z4	Vend request, USD requests approval to vend a specified item from VMC.
		02	Vend or home success, requested vend or home was successful.
		03 + 4 bytes Z1 - Z4	Vend or home fail, requested vend or home has failed. Reason for failure is returned.
		04 + 6 bytes Z1 - Z6	USD configuration and setup data.
		05 + 2 bytes Z1 - Z2	USD item price request.
		06 + 2 bytes Z1 - Z2	USD Error codes.
		07 + 34 bytes Z1 - Z34	USD Peripheral ID string.
		08 + 4 bytes Z1 - Z4	USD Status response.
		09 + <i>n</i> bytes Z1 - Z <i>n</i>	USD multiple data block transfer response.
		0A + <i>n</i> bytes Z1 - Z <i>n</i>	USD single data block response
		1B + 5 bytes Z2 - Z6	FTL REQ TO RCV response
		1C + 3 bytes Z2 - Z4	FTL RETRY / DENY response
		1D + <i>n</i> bytes Z2 - Z <i>n</i>	FTL SEND BLOCK response
		1E + 2 bytes Z2 - Z3	FTL OK TO SEND response
		1F + 5 bytes Z2 - Z6	FTL REQ TO SEND response
		FF + Z1 - Z <i>n</i>	USD Diagnostic response.

The **POLL** command is used by the VMC to obtain status information from the USD. The same command is used by the USD to indicate a reset, request a vend, indicate vend success, indicate the reason for a vend failure, request the price of an item, send configuration and/or error data, return the USD's peripheral identification string, control the transmission and reception of data blocks, return a status and/or diagnostic response.

The USD responds to the **POLL** command with either an ACK, or a multi-byte response if there is more information to convey.

Data sequence transmitted by the USD to the VMC after a *Reset Request*

USD Response	Meaning or interpretation
00	The 00 response indicates that the USD has just been reset or wishes to be reset ⁵ .

Data sequence transmitted by the USD to the VMC for a *Vend Request*

USD Response	Meaning or interpretation
01 + Z1- Z2 =	Selection in 2 bytes. Indicates the product to be vended by item number, defined by the manufacturer, as part of a vend request.
Z3 - Z4 =	Scaled product price in 2 bytes (word). Indicates the price of the product to be vended divided by the scaling factor. A price of FFFF is transmitted if the USD does not contain price information.

Data sequence transmitted by the USD to the VMC after a *Vend or Home success*

USD Response	Meaning or interpretation
02	Indicates that the requested vend or home was successful.

Data sequence transmitted by the USD to the VMC after a *Vend or Home Fail*

USD Response	Meaning or interpretation
03 + Z1 - Z2 =	USD item number, defined by the manufacturer.
Z3 - Z4 =	Bits: b0 = Selection sold out. b1 = Selection motor / actuator jam. b2 = Non-existent motor / actuator. b3 = Invalid selection range ⁶ . b4 = Health safety error. b5 - b15 = Not defined.

⁵ The VMC is expected to reconcile whether the USD is transmitting a 00 in confirmation of a VMC issued reset that has just occurred, or as an unsolicited request to be reset. The context of the VMC's prior communication activity should be used in making this assessment.

Data sequence transmitted by the USD to the VMC if *SETUP* response delayed

USD Response	Meaning or interpretation
04 + Z1 =	USD Feature level, Indicates current feature level of the USD. The currently defined level is one. ⁷
Z2 - Z3 =	Maximum price on USD 2 bytes (word). Indicates the highest priced item on the USD. ⁸ USD should return FF FFh if it does not have internal pricing capability.
Z4 - Z5 =	Item number, defined by the manufacturer.
Z6 =	USD maximum application response time in seconds, FF = 255 seconds.

Data sequence transmitted by the USD if the *USD* needs pricing information

USD Response	Meaning or interpretation
05 + Z1 - Z2 =	Item number, defined by the manufacturer.

Data sequence transmitted by the USD if the *USD* has a failure to report to VMC

USD Response	Meaning or Interpretation
06 + Z1 - Z2 =	Bits: b0 = Health Safety violation. b1 = Home or Chute sensor failure b2 = Keypad or Selection switch failure b3 - b15 = Not defined.

Data sequence transmitted by the USD for peripheral ID

⁶ This error code is included to identify actuators that may not be present within the initially defined row and column configuration. See bytes Z4 and Z5 of the USD's setup response. This is typical in a snack machine implementation where some trays may not be populated with a full complement of motors and/or actuators.

⁷ Feature level of the USD is sent to allow the VMC to arbitrate command compatibility with the USD. The USD may have elected to transmit this setup data in fulfillment of an earlier **SETUP** command.

⁸ The maximum price on the USD is returned to the VMC so this price can be used in the computation of maximum credit acceptance.

USD Response	Meaning or Interpretation
07 + Z1 - Z3 =	Manufacturer ID Code.
Z4 - Z15 =	USD Serial Number.
Z16 - Z27 =	USD Model Number.
Z28 - Z29 =	USD Software Version.
Z30 - Z33 =	Optional feature bits.

Data sequence transmitted by the USD to the VMC after a Status request

USD Response	Meaning or interpretation
08 + Z1 - Z2 =	Item number, defined by the manufacturer.
Z3 - Z4 =	Bits: b0 = Selection sold out. b1 = Selection motor / actuator jam. b2 = Non-existent motor / actuator. b3 = Invalid selection range. b4 = Health safety error. b5 - b15 = Not defined.

Data sequence transmitted by the USD to the VMC after a USD data transfer command

USD Response	Meaning or interpretation
09 + Z1 =	Z1 = 00 USD requests to receive data block Z2 from VMC Z1 = 01 USD requests to send Z2 data block(s) to VMC Z1 = 02 USD data block response where: Z2 = data block number Z3 - Zn = contents of data block
Z2 =	Z2 = Block number USD requests to receive if Z1 = 00 Z2 = Number of blocks the USD requests to send if Z1 = 01 Z2 = Block number the USD is sending if Z1 = 02.
Z3 - Zn =	Contents of data block sent by USD to VMC if Z1 = 02

Data sequence transmitted by the USD to the VMC to send a single block of data

USD Response	Meaning or interpretation
0A + Z1 - Zn=	Z1 -Zn = Arbitrary data to be received by the VMC. The number "n" must be less than 35 per MDB standards

Data sequence transmitted by the USD to the VMC after an File Transport Layer (FTL) REQ TO RCV command

USD Response	Meaning or interpretation
Z1=1B + Z2 - Z6	The USD is requesting to receive data from a device or VMC Z2 = Destination address of response Z3 = Source address of response (40H, 48H, 50H) Z4 = File ID Z5 = Maximum length Z6 = Control

Data sequence transmitted by the USD to the VMC after an File Transport Layer (FTL) RETRY / DENY command

USD Response	Meaning or interpretation
Z1=1C + Z2 - Z4	The USD is requesting a device or VMC to retry or deny the last FTL command. Z2 = Destination address of response Z3 = Source address of response (40H, 48H, 50H) Z4 = Retry delay

Data sequence transmitted by the USD to the VMC after an File Transport Layer (FTL) SEND BLOCK command

USD Response	Meaning or interpretation
Z1=1D + Z2 - Z34	The USD is sending a block of data (maximum of 31 bytes) to a device or VMC. Z2 = Destination address of response Z3 = Block # Z4 - Z34 = Data (maximum of 31 bytes)

Data sequence transmitted by the USD to the VMC after an File Transport Layer (FTL) OK TO SEND command

USD Response	Meaning or interpretation
Z1=1E + Z2 - Z3	The USD is indicating that it is OK for the device or VMC to send it data. Z2 = Destination address of response Z3 = Source address of response (40H, 48H, 50H)

Data sequence transmitted by the USD to the VMC after an File Transport Layer (FTL) REQ TO SEND command

USD Response	Meaning or interpretation
Z1=1F + Z2 - Z6	The USD is requesting to send data to a device or VMC. Z2 = Destination address of response Z3 = Source address of response (40H, 48H, 50H) Z4 = File ID Z5 = Maximum length Z6 = Control

Data sequence transmitted by the USD to the VMC after a diagnostic command

USD Response	Meaning or interpretation
FF + Z1 - Zn =	Diagnostic response.

9.3.4 VEND

Command	Code	Sub-Cmd	VMC Data	Response Data
VEND	43	00	none	none
	43	01	none	none
	43	02	2 bytes Y1-Y2	none
	43	03	2 bytes Y1-Y2	none
	43	04	2 bytes Y1-Y2	5 bytes: 08 + Z1 - Z4

The **VEND** command is the vehicle that the VMC uses to signal vend approval or disapproval in response to a USD issued vend request (**POLL** response 01). The

VEND command can also be used by the VMC to initiate a vend, home a selection, or query the status of a selection on the USD.

Sub Cmd:	Meaning or interpretation
00 =	Requested vend approved.
01 =	Requested vend disapproved.
02 =	Vend specified Item number, defined by the manufacturer.
03 =	Home specified Item number, defined by the manufacturer.
04 =	Request status of specified Item number, defined by the manufacturer.

Data sequence transmitted by the USD to the VMC after a Status request

USD Response	Meaning or interpretation
08 + Z1 - Z2 =	Item number, defined by the manufacturer.
Z3 - Z4 =	Bits: b0 = Selection sold out. b1 = Selection motor / actuator jam. b2 = Non-existent motor / actuator. b3 = Invalid selection range. b4 = Health safety error. b5 - b15 = Not defined.

9.3.5 FUNDS

Command	Code	Sub-Cmd	VMC Data	Response Data
FUNDS	44	00	2 bytes: Y1-Y2	none
	44	01	6 bytes: Y1-Y6	none

The **FUNDS** command is the vehicle the VMC should use to specify the funds available for vending. The **FUNDS** 00 command is issued by the VMC whenever the level of credit changes. Typically, the USD would display the credit information returned by a **FUNDS** 00 command on a credit display. The **FUNDS** 01 is issued by the VMC in response to an item price request (**POLL** response 05) by the USD.

Sub-Cmd	Meaning or interpretation
00 + Y1 - Y2 =	Funds available in 2 bytes (word), scaled by the coin scaling factor.

Sub Cmd	Meaning or interpretation
01 + Y1 - Y2 =	Item number, defined by the manufacturer.
Y3 - Y4 =	Selection price in 2 bytes (word) scaled by coin scaling factor.
Y5 - Y6 =	Alphanumeric selection identifier 2 bytes (word), or FFFF if not available. ⁹

9.3.6 CONTROL

Command	Code	Sub-Cmd	VMC Data	Response Data
CONTROL	45	00	none	none
	45	01	none	none

This command is the vehicle the VMC should use to enable or disable the USD.

Sub-Cmd	Meaning or interpretation
00	Disable USD.
01	Enable USD.

9.3.7 EXPANSION

Command	Code	Sub-Cmd	VMC Data	Response Data
EXPANSION	47	00	None	07 + Z1 - Z34 Peripheral ID string and feature bits.
	47	01	Y1 - Y4	none
	47	02	Y1	none
	47	03	Y1 - Y _n	none
	47	04	Y1	09 + Z1 + Z2 - Z _n
	47	05	Y1 - Y _n	none
	47	FA	Y1 - Y5	1D + Z2 - Z34 or 1C + Z2 - Z4
	47	FB	Y1 - Y3	none
	47	FC	Y1 - Y33	none
	47	FD	Y1 - Y2	1D + Z2 - Z34

⁹ Alpha-numeric selection identifier is provided to the USD for display purposes only.

	47	FE	Y1 - Y5	1E + Z2 - Z3 or 1C + Z2 - Z4
	47	FF	Diagnostics	Diagnostic response.

Data sequence transmitted by the USD to the VMC after an expansion 00 sub-command

USD Response	Meaning or Interpretation
07 + Z1 - Z3 =	Manufacturer ID Code.
Z4 - Z15 =	USD Serial Number.
Z16 - Z27 =	USD Model Number.
Z28 - Z29 =	USD Software Version.
Z30 - Z33 =	Optional feature bits: b0 = USD is capable of storing and controlling pricing. b1 = USD is capable of selecting items to vend. b2 = USD is capable of supporting the File Transport Layer. This support is defined in Section 2.6. b3 - b31 = Available for future use.

Sub-Command used by the VMC to enable optional feature bits on the USD

Sub-Cmd	Meaning or interpretation
01 + Y1 - Y4	Enable optional feature bits defined in Z31-Z34 above. Feature is enabled if bit is set to 1, all features are disabled after a reset.

Sub-Command used by the VMC to identify the number of data blocks it wishes to send to the USD

Sub-Cmd	Meaning or interpretation
02 + Y1	Number of data blocks the VMC has to send to the USD (Binary)

Sub-Command used by the VMC to transmit a data block to the USD (Y2-Yn) and to identify the current block number being transmitted (Y1)

Sub-Cmd	Meaning or interpretation
---------	---------------------------

03 + Y1	Block number the VMC is transmitting to the USD
Y2 - Yn ¹⁰	Data the VMC is transmitting to the USD

Sub-Command used by the VMC to request that the USD send or re-send data block number (Y1)

Sub-Cmd	Meaning or interpretation
04 + Y1	VMC requests USD to send block Y1

Sub-Command used by the VMC to send a single block of data to the USD

Sub-Cmd	Meaning or interpretation
05 + Y1 - Yn	VMC sends a single block of data consisting of Y1..Yn

Sub-Command used by the VMC for an FTL REQ TO RCV. The Z1- Zn response can be either immediate or delayed (POLLED).

Sub-Cmd	Meaning or interpretation
FA + Y1 - Y5	<p>The VMC is requesting to receive data from the USD whose destination address will always be (40H, 48H, 50H). Note that all FTL Commands / Responses are defined in Section 2.6.</p> <p>Y1 = Destination address of command (40H,48H,50H) Y2 = Source address of command Y3 = File ID Y4 = Maximum length Y5 = Control</p>
USD Response	Meaning or interpretation
Z1 - Z34	<p>Z1 = 1DH which indicates SEND BLOCK Z2 = Destination address of data Z3 = Block # Z4 - Z34 = Data (maximum of 31 bytes)</p>
or	or
Z1 - Z4	<p>Z1 = 1CH which indicates RETRY / DENY Z2 = Destination address of response Z3 = Source address of response (40H,48H,50H) Z4 = Retry delay</p>

¹⁰ The number "n" is limited by the MDB maximum message length of 36 bytes.

Sub-Command used by the VMC for an FTL RETRY / DENY.

Sub-Cmd	Meaning or interpretation
FB + Y1 - Y3	<p>The VMC is retrying, denying, or aborting a data transfer to/from the USD whose destination address will always be (40H, 48H, 50H). Note that all FTL Commands / Responses are defined in Section 2.6.</p> <p>Y1 = Destination address of command (40H,48H,50H) Y2 = Source address of command Y3 = Retry delay</p>

Sub-Command used by the VMC for an FTL SEND BLOCK.

Sub-Cmd	Meaning or interpretation
FC + Y1 - Y33	<p>The VMC is sending data to the USD whose destination address will always be (40H, 48H, 50H). Note that all FTL Commands / Responses are defined in Section 2.6.</p> <p>Y1 = Destination address of command (40H,48H,50H) Y2 = Block # Y3 - Y33 = Data (maximum of 31 bytes)</p>

Sub-Command used by the VMC for an FTL OK TO SEND. The Z1 to Z33 response can be either immediate or delayed (POLLED).

Sub-Cmd	Meaning or interpretation
FD + Y1 - Y2	<p>The VMC is requesting to receive data from the USD whose destination address will always be (40H, 48H, 50H). Note that all FTL Commands / Responses are defined in Section 2.6.</p> <p>Y1 = Destination address of command (40H,48H,50H) Y2 = Source address of command</p>
USD Response Z1 - Z34	<p>Meaning or Interpretation</p> <p>Z1 = 1DH which indicates SEND BLOCK Z2 = Destination address of data Z3 = Source address of data Z4 - Z34 = Data (maximum of 31 bytes)</p>

Sub-Command used by the VMC for an FTL REQ TO SEND. The Z1 - Zn response can be either immediate or delayed (POLLED).

Sub-Cmd	Meaning or interpretation
FE + Y1 - Y5	<p>The VMC is requesting to send data to the USD whose destination address will always be (40H, 48H, 50H). Note that all FTL Commands / Responses are defined in Section 2.6.</p> <p>Y1 = Destination address of command (40H,48H,50H) Y2 = Source address of command Y3 = File ID Y4 = Maximum length Y5 = Control</p>
USD Response	Meaning or Interpretation
Z1 - Z34	<p>Z1 = 1EH which indicates OK TO SEND Z2 = Destination address of response Z3 = Source address of response (40H,48H,50H)</p>
or	or
Z1 - Z4	<p>Z1 = 1CH which indicates RETRY / DENY Z2 = Destination address of response Z3 = Source address of response (40H,48H,50H) Z4 = Retry delay</p>

Data sequence transmitted by the USD to the VMC after a diagnostic command

USD Response	Meaning or interpretation
FF + Z1 - Zn =	Diagnostic response.

9.4 USD Power Requirements

This section defines the maximum power requirements for a USD.

USD peripherals may draw power from the MDB bus or from an integral power supply. In such cases where the USD will require power from the MDB bus, the current draw must remain within the following limits:

USD Mode	Current draw
Idle	200 mA (maximum continuous)
Vending/Homing	1.75 A (for up to 10 seconds)

9.5 Examples – Mode 1 / 2 / 3 Sessions

This section contains three examples of USD sessions in which each of the three modes of USD operation are demonstrated operation respectively.

9.5.1 MODE ONE

In this example session the VMC selects the item to vend and knows the vend price. The USD receives the vend command, attempts the vend, and reports if the attempted vend failed or was successful.

VMC	MDB Data	Explanation	USD
⇒	43+02+01+03	VMC requests to vend item from the USD.	
	<ACK>	USD acks vend request.	⇐
⇒	42	VMC polls the USD.	
	<ACK>	USD acks receipt of poll.	⇐
⇒	42	VMC polls the USD again .	
	02	USD responds: vend complete	⇐
⇒	<ACK>	VMC acks vend outcome.	

9.5.2 MODE TWO

In this example session the USD or the VMC can select items to vend but the USD may not be aware of the vend price of the item selected. If the USD needs the selected item price, it may request the item price from the VMC. The USD must then issue a **VEND** request, and wait for approval from the VMC before a vend is attempted. The VMC then approves or denies the requested vend and polls the USD for vend success or vend fail.

VMC	MDB Data	Explanation	USD
⇒	42	VMC polls the USD.	
	05+02+06	USD responds with pricing request for item in USD.	⇐
⇒	<ACK>	VMC acks the USD price request.	
⇒	44+01+02+06+00+1 4 +FF+FF	Using the Funds command the VMC sends a price of 20 coin factors for item in USD.	
	<ACK>	USD acks receipt of VMC price data.	⇐
⇒	42	VMC polls the USD.	
	01+02+06+FF+FF	USD responds with a request to vend item in USD at the VMC selected price.	⇐
⇒	<ACK>	VMC acks receipt of vend request.	
⇒	43 + 00 or 01	VMC approves or denies vend request.	
	<ACK>	USD acks receipt of approval or denial.	⇐
⇒	42	VMC polls the USD.	
	03+02+06+00+01	USD responds: vend fail, sold out.	⇐
⇒	<ACK>	VMC acks vend outcome.	

- The **FUNDS** command can be used by USD's which do not have internal prices but need pricing information for display purposes or for other reasons that are not required to complete a transaction.

9.5.3 MODE THREE

In this example session the USD selects the item to vend and is aware of the vend price of the item. The USD must issue a vend request and the VMC then approves or denies the requested vend. The VMC then polls the USD for vend success or vend fail.

VMC	MDB Data	Explanation	USD
⇒	42	VMC polls the USD.	
	01+03+02+00+1E	USD requests vend for item at in USD with price of 30 coin factors.	⇐
⇒	<ACK>	VMC acks the USD vend request.	
⇒	43+ 00 or 01	VMC approves or denies vend request.	
	<ACK>	USD acks receipt of approval or denial.	⇐
⇒	42	VMC polls the USD.	
	02	USD responds: vend complete	⇐
⇒	<ACK>	VMC acks vend outcome.	

9.6 Examples - Data Block Transfers

This section contains two examples in which data blocks are transferred between the VMC and the USD and vice versa.

9.6.1 Data Block Transfer from VMC to USD

In this example the VMC wishes to send two data blocks to the USD. To do this, the VMC uses the expansion 02 command to advise the USD of its request to send data and also to identify the number of data blocks it wishes to send. In response, the USD uses a poll 09 to request the transmission of a data block with the block number enumerated as part of its poll response. The VMC then uses a different expansion command (03) to send the data to the USD.

VMC	MDB Data	Explanation	USD
⇒	47+02+02	VMC issues a request to send two data blocks to the USD	
	<ACK>	USD acks receipt of the request	⇐
⇒	42	VMC polls the USD	
	09+00+01	USD responds with a request to receive data block number 01 from the VMC	⇐
⇒	<ACK>	VMC acks receipt of block number	
⇒	47+03+01+21+22+23	VMC transmits block number 01 containing data: 21, 22, and 23.	
	<ACK>	USD acks receipt of the data block	⇐
⇒	42	VMC polls the USD.	
	09+00+02	USD responds with a request to receive data block number 02 from the VMC.	⇐
⇒	<ACK>	VMC acks receipt of the block number.	
⇒	47+03+02+24+25+26	VMC transmits block number 02 containing data: 24, 25, and 26.	
	<ACK>	USD acks receipt of the data block	⇐

9.6.2 Data Block Transfer from USD to VMC

In this example the USD wishes to send two data blocks to the VMC. To do this, the USD makes use of the Poll 09 command to inform the VMC of its request to send data and also to identify the number of data blocks it wishes to send. In response, the VMC uses expansion 04 command to request the transmission of a data block by the individual block number. The USD then uses the poll 09 response to send the data blocks to the VMC.

VMC	MDB Data	Explanation	USD
⇒	42	VMC polls the USD	
	09+01+02	USD responds with a request to send 2 data blocks to the VMC	⇐
⇒	<ACK>	VMC acks request to send data	
⇒	47+04+01	VMC responds with a request to receive data block number 01 from the USD	
	<ACK>	USD acks receipt of block number request	⇐
⇒	42	VMC polls the USD	
	09+02+01+55+56+57	USD responds by transmitting block number 01 containing data 55, 56, and 57.	⇐
⇒	<ACK>	VMC acks receipt of data	
⇒	47+04+02	VMC responds with a request to receive data block number 02 from the USD	
	<ACK>	USD acks receipt of block number request	⇐
⇒	42	VMC polls the USD	
	09+02+02+58+59+60	USD responds by transmitting block number 02 containing data 58, 59, and 60.	⇐
⇒	<ACK>	VMC acks receipt of data	

9.7 Universal Satellite Device Examples

Reset Sequence		USD	Comments
Controller			
RESET (40)	→		Reset command
	←	ACK	
POLL (42)	→		
	←	JUST RESET (00)	Must be sent once
ACK	→		
SETUP (41)	→		Establish operation configuration
	←	CONFIG. (04...)	
ACK	→		
EXPANSION/ID (47/00...)	→		Send asset information
	←	PERIPHERAL ID (07...)	Get asset information
ACK	→		
EXPANSION/FEATURE ENABLE (47/01...)	→		Enable additional feature if necessary
	←	ACK	
VEND/STATUS REQUEST (43/04 01 01)	→		Check the status of column 1
	←	ACK	
POLL (42)	→		
	←	STATUS (08...)	Status of column 1
ACK	→		
	·		
	·		
	·		
CONTROL/ENABLE (45/01)	→		Enable command
	←	ACK	
VEND/HOME REQUEST (43/03 01 01)	→		Home column 1
	←	ACK	
POLL (42)	→		
	←	VEND COMPLETE (02...)	Homing of column 1 completed
ACK	→		
	·		
	·		
	·		
Enable Sequence		USD	Comments
Controller			
CONTROL/ENABLE (45/01)	→		Enable command
	←	ACK	
Disable Sequence		USD	Comments
Controller			
CONTROL/DISABLE (45/00)	→		Disable command
	←	ACK	

Vend Sequence			
Controller		USD	Comments
FUNDS/FUNDS AVAIL (43...)	→		Post funds available to alert device of pending activity
	←	ACK	
POLL	→		Waiting for activity
	←	ACK	
VEND/VEND REQUEST (43/02 01 03)	→		Vend from row 1, col. 3
	←	ACK	
POLL (42)	→		
	←	ACK	Nothing to report
	.		waiting for vend to complete
	.		
	.		
POLL (42)	→		
	←	VEND COMPLETE (02)	or VEND FAIL (03...)
ACK	→		
Error Sequence			
Controller		USD	Comments
POLL (42)	→		
	←	ERROR (06...)	Sent once for each error
ACK	→		

(this page intentionally left blank)

Section 10

Coin Hopper or Tube - Dispenser VMC/Peripheral Communication Specifications

10.1 Introduction

This section defines the communication bytes sent and received by a coin dispensing device, which may be in the form of a hopper or tube device. As defined in Section 2.3, there are two dispenser device addresses; Dispenser #1, 01011xxxB (58H) and Dispenser #2, 01110xxxB (70H). The second address has been assigned to allow for two unique forms of dispenser devices to be resident in the vending machine simultaneously. **Everything defined in this section will be common to the two dispenser devices – only the addresses will be different.**

Unless stated otherwise, all information is assumed to be in a binary format

10.2 VMC Commands

<u>Command</u>	<u>Hex Code</u>	<u>Description</u>
RESET	58H / 70H	Command for dispenser to self-reset
SETUP	59H / 71H	Request for dispenser setup.
DISPENSER STATUS	5AH / 72H	Request for dispenser tube / hopper status and coin count.
POLL	5BH / 73H	Request for dispenser activity status.
MANUAL DISPENSE ENABLE	5CH / 74H	Signifies coin types allowable for coin dispensing. This command is followed by setup data. See command format section.
DISPENSE *	5DH / 75H	Command to dispense coins. Followed by coin type or value to dispense. See command format section.
PAYOUT *	5EH / 76H	Command to determine value of coins dispensed. Followed by payout status or value poll. See command format section.
EXPANSION *	5FH / 77H	Command to allow addition of features, File Transport Layer, and future enhancements. See command format section.

* **NOTE:** DISPENSE, PAYOUT, and EXPANSION commands are always followed by a "sub-command."

10.3 VMC Command Format

<u>VMC Command</u>	<u>Code</u>	<u>VMC Data</u>
RESET	58H / 70H	No data bytes

This command is the vehicle that the VMC should use to tell the dispenser that it should return to its default operating mode and initialize internal hardware systems. With the exception of the ACK response, it should abort all communication until otherwise instructed by the VMC.

The following initialization sequence is recommended. It should be used after “power up” or after issuing the Bus Reset (pulling the transmit line “active” for a minimum of 100 mS).

RESET – 58h / 70h

POLL – 5Bh / 73h

To obtain “JUST RESET” response

SETUP – 59h / 71h

To obtain dispenser level and configuration information

EXPANSION IDENTIFICATION – 5F 00h / 77 00h

To obtain additional dispenser information and options

EXPANSION FEATURE ENABLE – 5F 01h / 77 01h

To enable desired options

DISPENSER STATUS – 5Ah / 72h (Note 1)

To obtain dispenser status / change information

MANUAL DISPENSE ENABLE – 5Ch / 74h

To enable and disable manual coin pay-out if desired

No power above idle current can be drawn until after the first POLL following the RESET command. Also, the JUST RESET response to the POLL command must be delayed until any high current usage has been completed.

The dispenser must hold its response of the DISPENSER status until a valid current reading from the sensor system is achieved.

<u>VMC Command</u>	<u>Code</u>	<u>Dispenser Response Data</u>
SETUP	59H / 71H	26 bytes: Z1 - Z26
Z1 =	Dispenser Feature Level - 1 byte	Indicates the feature level of the dispenser. This will distinguish the dispensers feature level to the VMC. Currently only level 1 is supported.
Z2 - Z3 =	Country / Currency Code - 2 bytes	The packed BCD currency code of the dispenser is sent with the left most digit a 1. See Appendix A1 for the latest version of the ISO 4217 numeric currency code. For example, the code for the US dollar is 18 40H (Z2 = 18 and Z3 = 40) and for the Euro is 19 78 (Z2 = 19 and Z3 = 78).
Z4 =	Coin Scaling Factor - 1 byte	All dispensed coin values must be evenly divisible by this number. For example, this could be set to 05H for the USA nickel.
Z5 =	Decimal Places - 1 byte	Indicates the number of decimal places on a credit display. For example, this could be set to 02H in the USA.
Z6 =	Application Maximum Response Time (seconds) – 1 byte	The maximum length of time a dispenser will require to provide a response to any command from the VMC. The value reported here supercedes the dispenser's default NON-RESPONSE time defined in section 10.4 if the value reported here is greater.
Z7 – Z8 =	Bit set, if coin disabled by dispenser (i.e. switch).	
Z9 – Z10 =	Bit set, if coin is self filling.	
Z11 - Z26 =	Coin Type Credit - 16 bytes	Indicates the value of coin types 0 to 15. Values must be sent in ascending order. This number is the coin's monetary value divided by the coin scaling factor. Unused coin types are sent as 00H. Unsent coin types are assumed to be zero. It is not necessary to send all coin types. Coin type credits sent as FFH are assumed to be vend tokens. That is, their value is assumed to be worth one vend. The byte position in the 16 byte string indicates the coin type(s). For example, the first byte sent would indicate the value of coin type 0, the second byte sent would indicate the value of coin type 1, and so on. For example, the USA coin types may be; Coin type 0 = nickel, Coin type 1 = dime, Coin type 2 = quarter, Coin type 3 = dollar.

<u>VMC Command</u>	<u>Code</u>	<u>Dispenser Response Data</u>
DISPENSER STATUS	5AH / 72H	34 bytes: Z1 – Z34

Z1 - Z2 = Dispenser Full Status - 2 bytes

Indicates status of coin tube / hopper for coin types 0 to 15.

b15 b14 b13 b12 b11 b10 b9 b8 | b7 b6 b5 b4 b3 b2 b1 b0
 Z1 Z2

A bit is set to indicate a full dispenser. For example, bit 7 = set would indicate the dispenser for coin type 7 is full.

Z3 – Z34 = Coin Count - 32 bytes

Indicates the greatest number of coins that the dispenser “knows” definitely are present in the coin tube / hopper. A word (2 bytes) position in the 32 byte string indicates the number of coins in a tube / hopper for a particular coin type. For example, the first 2 bytes sent indicate the number of coins in a tube / hopper for coin type 0. Unsent bytes are assumed to be zero. For tube / hopper counts greater than 65535, counts should remain at 65535.

NOTE: If a dispenser can detect a tube or hopper jam, defective tube or hopper sensor, or other malfunction, it will indicate the tube / hopper is "bad" by sending a tube / hopper full status and a count of zero for the malfunctioning coin type.

<u>VMC Command</u>	<u>Code</u>	<u>Dispenser Response Data</u>
POLL	5BH / 73H	32 bytes: Z1 – Z32

Z1 - Z32 = Dispenser Activity - 32 bytes

Indicates the dispenser activity. If there is nothing to report, the dispenser should send only an ACK. Otherwise, the only valid responses are:

Coins Dispensed:

This response should be sent once at the end of a payout cycle.

Z1 (10yzxxx)

z z =1 for manual dispense
 z =0 to report a non manual (automatic) dispense

y y =1 for payout completed successfully
 y =0 for payout completed unsuccessfully (aborted)

xxx The coin type dispensed (0 to 15)

Z2 - Z3 The number of coins dispensed.

Z4 – Z5 The number of coins in the dispenser.

Status:

(00000001) =	Escrow request ¹ - An escrow lever activation has been detected. If a button is present and activated.
(00000010) =	Dispenser Payout Busy ² - The dispenser is busy activating payout devices.
(00000011) =	Not Used
(00000100) =	Defective Dispenser Sensor ¹ - The dispenser has detected one of the dispenser sensors behaving abnormally.
(00000101) =	Not Used
(00000110) =	Dispenser did not start ¹ .
(00000111) =	Dispenser Jam ¹ - A dispenser payout attempt has resulted in jammed condition.
(00001000) =	ROM checksum error ¹ - The dispensers internal checksum does not match the calculated checksum.
(00001001) =	Not Used
(00001010) =	Not Used
(00001011) =	Dispenser was "Just Reset" ¹ - The dispenser has detected a Reset condition and has returned to its power-on idle condition.
(00001100) =	Not Used
(00001101) =	Not Used
(00001110) =	Not Used
(00001111) =	Filled key pressed ¹ - The VMC should request a new DISPENSER STATUS.

NOTES:

The dispenser may send several of one type activity, up to 16 bytes total. This will permit zeroing counters such as inventory and status.

1 Sent once each occurrence.

2 Sent once each POLL

File Transport Layer POLLed responses:

Note that all FTL responses are defined in Section 2.6. For the coin dispenser, the source address will always be the dispenser (58H/70H) as defined in Section 2.3.

Z1

1B	REQ TO RCV	<p>The coin dispenser is requesting to receive data from a device or VMC.</p> <p>Z2 = Destination address of response Z3 = Source address of response (58H/70H) Z4 = File ID Z5 = Maximum length Z6 = Control</p>
1C	RETRY/DENY	<p>The coin dispenser is requesting a device or VMC to retry or deny the last FTL command.</p> <p>Z2 = Destination address of response Z3 = Source address of response (58H/70H) Z4 = Retry delay</p>
1D	SEND BLOCK	<p>The coin dispenser is sending a block of data (maximum of 31 bytes) to a device or VMC.</p> <p>Z2 = Destination address of data Z3 = Block # Z4-Z34 = Data (maximum of 31 bytes)</p>
1E	OK TO SEND	<p>The coin dispenser is indicating that it is OK for a device or VMC to send it data.</p> <p>Z2 = Destination address of response Z3 = Source address of response (58H/70H)</p>
1F	REQ TO SEND	<p>The coin dispenser is requesting to send data to a device or VMC.</p> <p>Z2 = Destination address of response Z3 = Source address of response (58H/70H) Z4 = File ID Z5 = Maximum length Z6 = Control</p>

<u>VMC Command</u>	<u>Code</u>	<u>VMC Data</u>
MANUAL DISPENSE ENABLE	5CH / 74H	2 bytes: Y1 – Y2

Y1 - Y2 = Manual Dispense Enable - 2 bytes

b15 b14 b13 b12 b11 b10 b9 b8 | b7 b6 b5 b4 b3 b2 b1 b0
 Y1 Y2

A bit is set to indicate dispense enable. For example, bit 2 is set to enable dispensing of coin type 2. This command enables/disables manual dispensing using optional inventory switches. All manual dispensing switches are automatically disabled upon reset.

<u>VMC Command</u>	<u>Code</u>	<u>Sub-command</u>	<u>VMC Data</u>
DISPENSE COINS	5DH / 75H	00H	3 bytes: Y1 – Y3

b7 b6 b5 b4 b3 b2 b1 b0
 Y1

Bits b3, b2, b1, b0 indicate coin type to be dispensed. Valid codes are 0H to FH to indicate coin types 0 to 15.

Bits b7, b6, b5, b4 = 0

Y2 - Y3 = Number of coins to be dispensed of coin type defined in Y1

There is no defined limit on how long the actual dispense takes since the command allows for up to 65535 coins to be paid out. The payout cycle begins when the dispenser ACKs the VMC's DISPENSE (5DH/75H) command. This cycle typically lasts a minimum of 100 mS and ends when the dispenser stops dispensing the desired number of coins. VMCs should monitor the Dispenser Payout Busy and Dispenser Activity response to the POLL (5BH/73H) command to determine when the entire payout cycle is completed.

<u>VMC Command</u>	<u>Code</u>	<u>Sub-command</u>	<u>VMC Data</u>
DISPENSE VALUE	5DH / 75H	01H	2 bytes: Y1, Y2

Y1 – Y2 = Value of coins to be paid out.

Y1 and Y2 are defined as the value of coins and this value is expressed as the number of coin scaling factors that would sum to the value. For example, in a USA system using a scaling factor of 05, if the change to be paid out is 75 cents, then Y1 will equal fifteen. That is, the sum of fifteen nickels equal 75 cents. The coin dispenser will determine which actual denominations of coins will be paid out. In the 75 cent example, the coins may be 3 quarters; or, 7 dimes & 1 nickel; or, 2 quarters & 2 dimes & 1 nickel, etc. The actual coins dispensed and if the dispense is finished can be acquired via the PAYOUT STATUS (5EH/76H, 00) and PAYOUT VALUE POLL (5EH/76H, 01).

<u>VMC Command</u>	<u>Code</u>	<u>Sub-command</u>	<u>VMC Data</u>	<u>Dispenser Response</u>
PAYOUT STATUS	5E / 76H	00H	None	32 bytes: Z1-Z32

Z1 – Z32 = Number of each coin type paid out - 32 bytes (2 bytes per coin type).

This is the dispenser's response to the last VMC DISPENSE VALUE command (5DH sub command 01H). Bytes are sent in ascending order of coin types. A bytes position in the string indicates the coin type. That is, bytes one and two are the number of coins for coin type 1, bytes three and four are the number of coins for coin type two, and so on. Unsent bytes above the coin types dispensed are assumed to be zero.

The dispenser clears payout data after an ACK response from the VMC.

The VMC should compare the value of the coins paid out to the (5DH/75H) DISPENSE VALUE command's Y2-Y3.

NOTES:

- 1) If the dispenser's payout is busy it will respond to the PAYOUT STATUS command with an ACK only.
- 2) If no coins have been paid out, at least one zero valued data byte must be sent.
- 3) There is no defined limit on how long the actual payout takes. See dispense command (5DH/75H) for further details

<u>VMC Command</u>	<u>Code</u>	<u>Sub-command</u>	<u>VMC Data</u>	<u>Dispenser Response Data</u>
PAYOUT VALUE POLL	5EH /76H	01H	None	2 bytes: Z1-Z2

Z1 – Z2 = Dispenser Payout Activity - 2 bytes

An interval value (scaled) which indicates the amount of paid out change since the previous PAYOUT VALUE POLL (or between the initial DISPENSE VALUE command (5DH/75H sub command 01H) and the first PAYOUT VALUE POLL).

A 00H response indicates no coins were paid out since the previous PAYOUT VALUE POLL (or the initial DISPENSE VALUE command (5DH/75H sub command 01H)).

An ACK only indicates that the change payout is finished. This should be followed by the PAYOUT STATUS command (5EH/76H-00H) to obtain the complete payout data.

NOTE: The initial intent of this command is to determine the amount of change paid out so that the credit display can be decremented as coins are dispensed.

<u>VMC Command</u>	<u>Code</u>	<u>Sub-Command</u>	<u>Dispenser Response Data</u>
EXPANSION COMMAND	5FH / 77H	00H	33 bytes: Z1 - Z33
	IDENTIFICATION		

- Z1 - Z3 = Manufacturer Code - 3 bytes
 Identification code for the equipment supplier. Sent as ASCII characters. Currently defined codes are listed in the **EVA** document entitled "**European Vending Association Data Transfer Standard**" (**EVA-DTS**), the Audit Data Lists section, sub-section 2, "Manufacturer Codes".
- Z4 - Z15 = Serial Number - 12 bytes
 Factory assigned serial number. All bytes must be sent as ASCII characters, zeros (30H) and blanks (20H) are acceptable.
- Z16 - Z27 = Model Number - 12 bytes
 Manufacturer assigned model number. All bytes must be sent as ASCII characters, zeros (30H) and blanks (20H) are acceptable.
- Z28 - Z29 = Software Version - 2 bytes
 Current software version. Must be sent in packed BCD.
- Z30 - Z33 = Optional Features - 4 bytes
 Each of the 32 bits indicate an optional features availability. If the bit is set the feature is available. Bits should be sent in descending order, i.e. bit 31 is sent first and bit 0 is sent last. Currently defined options are:
- b0 - File Transport Layer (FTL) supported as defined in Section 2.6.
 - b1 - b31 Available for future use

<u>VMC Command</u>	<u>Code</u>	<u>Sub-Command</u>	<u>VMC Data</u>
EXPANSION COMMAND	5FH / 77H	01H	4 bytes: Y1 - Y4
	FEATURE ENABLE		

This command is used to enable each of the optional features defined in Z30-Z33 above. To enable a feature a bit is set to one. **All optional features are disabled after reset.**

<u>VMC Command</u>	<u>Code</u>	<u>Sub-command</u>	<u>VMC Data</u>	<u>Dispenser Response</u>
EXPANSION COMMAND	5FH / 77H	FAH	Y1-Y5	Z1 - Zn (immediate or POLLED)
	FTL	REQ TO RCV		

The VMC is requesting to receive data from the dispenser whose destination address will always be (58H/70H). Note that all FTL Commands / Responses are defined in Section 2.6.

Y1 = Destination address of command (58H/70H)
 Y2 = Source address of command
 Y3 = File ID
 Y4 = Maximum length
 Y5 = Control

Z1 = 1DH which indicates SEND BLOCK
 Z2 = Destination address of data
 Z3 = Block #
 Z4 - Z34 = Data (maximum of 31 bytes)

or

Z1 = 1CH which indicates RETRY / DENY
 Z2 = Destination address of response
 Z3 = Source address of response (58H/70H)
 Z4 = Retry delay

<u>VMC Command</u>	<u>Code</u>	<u>Sub-command</u>	<u>VMC Data</u>	<u>Dispenser Response</u>
EXPANSION COMMAND	5FH / 77H	FBH	Y1-Y3	None
	FTL	RETRY / DENY		

The VMC is retrying, denying, or aborting a data transfer to/from the dispenser whose destination address will always be (58H/70H). Note that all FTL Commands / Responses are defined in Section 2.6.

Y1 = Destination address of command (58H/70H)
 Y2 = Source address of command
 Y3 = Retry delay

<u>VMC Command</u>	<u>Code</u>	<u>Sub-command</u>	<u>VMC Data</u>	<u>Dispenser Response</u>
EXPANSION COMMAND	5FH / 77H	FCH	Y1-Y33	None
	FTL SEND BLOCK			

The VMC is sending data to the dispenser whose destination address will always be (58H/70H). Note that all FTL Commands / Responses are defined in Section 2.6.

- Y1 = Destination address of command & data (58H/70H)
- Y2 = Block #
- Y3 - Y33 = Data (maximum of 31 bytes)

<u>VMC Command</u>	<u>Code</u>	<u>Sub-command</u>	<u>VMC Data</u>	<u>Dispenser Response</u>
EXPANSION COMMAND	5FH / 77H	FDH	Y1-Y2	Z1-Z34 (immediate or POLLED)
	FTL OK TO SEND			

The VMC is indicating that it is OK for the dispenser to transfer data. The destination address will always be the dispenser (58H/70H). Note that all FTL Commands / Responses are defined in Section 2.6.

- Y1 = Destination address of command (58H/70H)
- Y2 = Source address of command
- Z1 = 1DH which indicates SEND BLOCK
- Z2 = Destination address of data
- Z3 = Source address of data
- Z4 - Z34 = Data (maximum of 31 bytes)

<u>VMC Command</u>	<u>Code</u>	<u>Sub-command</u>	<u>VMC Data</u>	<u>Dispenser Response</u>
EXPANSION COMMAND	5FH / 77H	FEH	Y1-Y5	Z1 (immediate or POLLED)
	FTL REQ TO SEND			

The VMC is requesting to send data to the dispenser whose destination address will always be (58H/70H). Note that all FTL Commands / Responses are defined in Section 2.6.

- Y1 = Destination address of command (58H/70H)
- Y2 = Source address of command
- Y3 = File ID
- Y4 = Maximum length
- Y5 = Control

- Z1 = 1EH which indicates OK TO SEND
- Z2 = Destination address of response
- Z3 = Source address of response (58H/70H)
- or
- Z1 = 1CH which indicates RETRY / DENY
- Z2 = Destination address of response
- Z3 = Source address of response (58H/70H)
- Z4 = Retry delay

<u>VMC Command</u>	<u>Code</u>	<u>Sub-command</u>	<u>VMC Data</u>	<u>Dispenser Response</u>
EXPANSION COMMAND	5FH / 77H	FFH	Y1-Yn	Z1-Zn
	DIAGNOSTICS			

Y1 - Yn = Device manufacturer specific instruction for implementing various manufacturing or test modes. Y1 - Yn implies that any number of bytes can be used for the VMC data to the peripheral.

Z1 - Zn = Device manufacturer specific responses after receiving manufacturing or test instructions. Z1 - Zn implies that any number of bytes can be used for the Dispenser response data from the peripheral.

10.4 Dispenser Non-Response Time

The default maximum non-response time for the dispenser is 5 seconds. This is the maximum time for which a dispenser will not respond to a command or a POLL with ACK, NAK or a message. The "Application Maximum Response Time" reported in byte Z6 of the SETUP (10.3) supersedes this default value if Z6 is greater.

10.5 Dispenser Power Requirements

The current draw for any dispenser must fall within the following limits. All measurements are at the minimum VMC voltage output.

Idle mode = 200 mA. (max.) continuous

Coin payout = 2.5 A. (max.) for up to 15 seconds per coin dispensed. This is the maximum for all dispensers operating simultaneously in this unit.

Section 11

Age Verification Device

VMC/Peripheral Communication Specifications

11.1 Introduction

Due to legal restrictions, a variety of products are only allowed to be vended via vending machines by checking the customers age. The age and the rules vary from country to country.

This is i.e. related in some countries to cigarettes or alcoholic products. Some services or product contents may restrict a different age, related to the vending machine, this needs different ages to be checked within the same machine.

Age verification may be done with different electronic means, i.e. public cashless systems, which know the card users age, i.e. biometric systems, i.e. ID-card-readers or driving license readers, etc.

A common and state of the art usage in some countries is a public cashless system working as an Age Verification Device. Therefore it is good practice to define first an interface of commands as an addition to the cashless devices.

Second as MDB describes two cashless devices, which in some machines may be both only cashless readers, it is necessary to define an Age Verification Device only as an additional device, allowing the two readers within the machine working as before. The cashless readers which run as a multi-function device may choose to run the additional set of commands or respond as slaves on two peripheral addresses – the cashless 1 or 2 and the Age Verification Device address.

Therefore this paper describes two additional diagnostic commands for the cashless systems, to work as age verification devices. Second this paper describes a command set for an age verification device, which uses only two commands for age verification purpose -- the structure of these two commands is similar to the cashless diagnostic commands, therefore allowing any VMC, to use the same command interface for cashless and Age Verification Device as well.

These command are not bound to a cashless-transaction and may be therefore be used, if verification is done by other cards (i.e. without payment functions.) These command are independent of the cashless function (i.e. payment out of order, transaction memory full, ...) and do not interfere with the payment sequences. Sequences at MDB are changed slightly only.

Observing the age verification is done by the VMC. Only the VMC knows, what type of products it sells. The cashless device delivers the only information to VMC, whether the cashless media finds a valid age. The cashless device will approve a payment always, when the VMC requests this (MDB command request vend). The cashless device will not deny a payment, even if the age verification is not found. This allows simultaneous vend of age protected and free products from a vending machine.

After each power on or after reception of MDB-Reset the cashless device or Age Verification Device will ignore age verification. First after the VMC switches on age verification with the MDB-command "DRAVP" (Diagnostic Request Age Verification On) and Y4>0, verification cards will be checked. Only in this case the cashless device or Age Verification Device sends responses to the second new command "DRAVS" (Diagnostic Response Age Verification Status) to the VMC.

11.2 VMC Commands

The Age Verification Device uses the MDB address

0x68 (the next address after the second cashless device)

It implements a command set similar to a cashless device with a reduced command dictionary. All the not used commands are reserved for further use to hold the software functions compatible to a cashless subdevice.

The following describes the age verification commands common to the standalone Age Verification Device as well as a subdevice within the cashless device, whereas chapter 4 describes the additional setup commands for the standalone age verification device. Note, that these commands are the same commands as for a cashless device.

11.2.1 General Format EXPANSION Diagnostic

The MDB command EXPANSION Diagnostic allows transfer of manufacturer specific information between cashless reader and VMC. For transmission of the age verification information, the EXPANSION diagnostic command will be used. While implemented in a cashless device, this is similar to a virtual subdevice within the reader, whereas, when used with a separate address, these may be treated as normal standardized commands.

General format:

expansion (17H) (67H) (6FH)	Diagnostics (FFH) Y1	User Defined Data Y2-Yn
--------------------------------------	--------------------------------	----------------------------------

Y1 : DIAGNOSTICS.
Device manufacturer specific instruction for implementing various manufacturing or test modes.

Y2-Yn : User Defined Data.
The data portion of this command is defined by the manufacturer and is not part of this document.

Reader response:

Diagnostics Response (FFH) Z1	User Defined Z2-Zn
--	------------------------------

Z1 : DIAGNOSTICS RESPONSE

Z2-Zn : User Defined Data.
The data portion of this response is defined by the manufacturer and is not part of this document.

11.2.2 Switch On / Off of Age Verification

Diagnostic Request Age Verification On/Off (DRAVP)

This command is used to switch On or Off the age verification and to setup the minimum testing age within the device. While in state “on” each inserted media is checked and the result is messaged to the VMC.

After the VMC is powered on, the command DRAVP will be sent at least with Y4 = 0x00 or Y4 = 0xff to the age verification device.

Expansion	Diagnostics Request (FFH)	Age verification On/Off (0x05)	Length	Age	Ident
(17H)	Y1	Y2	Y3	Y4	Y5-Y9
(67H)					
(6FH)					

Diagnostics Response (FFH)	Age verification On/Off (0x05)	Length	Feature byte	Ident
Z1	Z2	Z3	Z4	Z5-Z9

- Y1 :** DIAGNOSTICS Request
- Y2 :** Age verification on/off
- Y3 :** Length, the number of bytes of this command, not including Y1-Y3, therefore set to 6.
- Y4** Age
- | | |
|--------------|--|
| Y4 = 0x00 | Switch off age verification. Additionally informs the card reader, that the VMC software supports age verification, but age verification is not necessary for any product |
| 0x00<Y4<0x64 | Level for age verification (0x01 - 0x63 = 1..99 years). Additionally informs the card reader, that the VMC software supports age verification and age verification is necessary |
| 0x63<Y4<0xFF | Reserved for future use |
| Y4 = 0xFF | Informs the card reader, that the VMC software supports age verification and that age verification will be switched on at xx.xx.xxxx automatically and the level of age will be changed to the default checking. |
- Y5-Y9** Ident “DRAVP” (hex 0x44 0x52 0x41 0x56 0x50)
- Used to prevent misinterpretation of this command and to separate it against possible other manufacturer defined 17 FF 05 commands.

The Age Verification Device takes the given age and responses with the diagnostic response. The VMC will detect, that an Age Verification Device is connected (or built in as a subdevice in cashless), which is doing age verification.

As the verification of the requested minimum age is depending of the (later) inserted media, the requested minimum age is only set to the age verification device. Whether a verification is really possible, will be messaged later within the DRAVS command.

The DRAVP command will be sent by VMC always after power up and after each RESET within the known initializing sequence to the Age Verification Device (cashless or stand alone). If the VMC is aware of a necessary age, the minimum age will be set to a value > 0, i.e. for today's cigarette vendor to 0x12 = 18.

If different products with different age levels are sold, the VMC may send this command before each vend transaction and temporarily change age due to selected product minimum age. Switch off of the age verification is only allowed, if all selections of the vendor do not require a verification.

The age verification device responds with:

- Z1 :** DIAGNOSTICS Response
- Z2 :** Age verification on/off
- Z3 :** Length, the number of bytes of this command, not including Z1-Z3, therefore set to 6.
- Z4** Feature Byte
 - b0 = 0 A customer card is not in reading position, but may be inserted (refer to b7)
 - b0 = 1 A customer card is in reading position.
 - b1...b6 Reserved, should be set to 0
 - b7= 0 A customer card is not inserted
 - b7= 1 A customer card is inserted, but may not be in reading position (refer to b0)
- Z5-Z9** Ident "DRAVP" (hex 0x44 0x52 0x41 0x56 0x50)

11.2.3 Check of Age Verification

Diagnostic Request Age Verification Status (DRAVS)

If the VMC activated the age verification with DRAVP, the Age Verification Device is checking each inserted media for age information and sends after insertion the DRAVS response to the VMC. The VMC may send the command itself to the age verification device, to get an actualisation of the status. The verification device answers with the actual response. The command may be sent in all MDB states (especially within cashless devices).

expansion	Diagnostics Request	Age verification Status	length	Features	Ident
(17H)	(FFH)	(0x06)			
(67H)	Y1	Y2	Y3	Y4	Y5-Y9
(6FH)					

Y1 : *DIAGNOSTICS Request*

Y2 : *Age Information*

Y3 : *length, the number of bytes of this command, not including Y1-Y3, therefore set to 6*

Y4 *Feature bits*
b0..b7: Reserved, should be set to 0

Y5-Y9 *Ident "DRAVS" (hex 0x44 0x52 0x41 0x56 0x53)*

If the VMC has activated the age verification with the DRAVP, each inserted media will be checked for age information and after insertion, the DRAVS response will be sent to the VMC.

Diagnostics Response (FFH)	Age (0x06)	length	feature byte 1	feature byte 2	Ident
Z1	Z2	Z3	Z4	Z5	Z6-Z10

- Z1 :** DIAGNOSTICS Response
- Z2 :** Age verification status
- Z3 :** length, the number of bytes of this command, not including Z1-Z3, therefore set to 7

- b0=0: A customer card is not in reading position, but may be
b0=1: A customer card is in reading position
- b1=0: Age information is not available on the customer card
b1=1: Age information is available on the customer card
- b2=0: Age verification is not possible (MSAM error or no MSAM)
b2=1: Age verification is possible (MSAM ok and present)
- b3=0: The age level from DRAVP command can't be checked
b3=1: The age level from DRAVP command (or a higher value) can be checked
- b4=0: The customer is not allowed to buy the product, because the age information on the card is less than the value in DRAVP
b4=1: The customer is allowed to buy the product, because the age information on the customer card is equal or greater than the value in DRAVP
- b5=0: reserved, should be set to zero
b6=0: Age verification information *) is valid
b6=1: Age verification information *) is invalid and set to 0, because age verification is under progress (busy)
- b7=0: A customer card is not inserted
b7=1: A customer card is inserted, but may not be in reading position (refer to b0)
- b0...b3: Reserved, should be set to 0

b4=1: Age verification done by private ident media 1

b5=1: Age verification done by private ident media 2

b6=1: Age verification done by driving license reader

b7=1: Age verification done by public cash card

Z6- Ident "DRAVS" (hex 0x44 0x52 0x41 0x56 0x53)
Z10

*) Age verification information refers to feature byte 1 (b1...b4) and feature byte 2 (all bits)

**) must be valid only, if age verification is positively checked (b4=1 of feature byte 1)

If a DRAVS response with positive checked age information sent from the age verification device, the VMC will enable the vend for selected product for typically 30 seconds. This duration should be programmable.

11.3 MDB Interface

11.3.1 MDB initializing

The general MDB-session consists of the known init-sequence as well as the polling sequence. The init sequence is extended with the DRAVP command.

RESET – 10h

POLL – 12h

To obtain “JUST RESET” response

SETUP CONFIGURATION DATA – 11 00h

To send the VMC's configuration data and obtain the reader's data

SETUP MAX/MIN PRICE – 11 01h

To send the maximum and minimum prices in the VMC. (Reader Level 01/02 syntax, 16 bit credit).

EXPANSION REQUEST ID – 17 00h

To obtain additional reader information and options (options in Level 03+ only)

EXPANSION ENABLE OPTIONS – 17 04h (Level 03+ only)

To enable desired options

SETUP MAX/MIN PRICE – 11 01h (Level 03+ and option bits 1 & 2 only)

To send the maximum and minimum prices in the VMC. (Reader Level 03+, 32 bit credit).

DRAVP – 17 ff 05 06 Age ‘D’ ‘R’ ‘A’ ‘V’ ‘P’ *)

switch on or off youth protection, set age level to be checked

POLL – 12h

To obtain “DRAVP” response

**)

READER ENABLE – 14 01h

To enable reader (if desired)

POLL – 12h

To obtain further responses, loop it.

*) the DRAVP may be sent in the following contents as often as needed, to switch on or off the verification or to change the verification age.

**) the cashless reader as well as the Age Verification Device are required to check the actual date and it is suggested for the VMC, to send an expansion diagnostic date/time command to actualize the date within the age verification device.

11.3.2 MDB Polling Loop, Vend Sequence

The polling loop will lead to a vend following the known sequence and is extended with an optional DRAVS.

Customer inserts card

POLL – 12h

DRAVS, card present, age verification status

POLL – 12h

Begin Session (value = 0, > 0 or -1). *)

Customer presses selection and/or inserts money.

VEND REQUEST – 13 00 xx xx xx xx yy yyh **)

ACK (xx = vend price, yy = selection number)

POLL – 12h

looped until vend approved or denied is sent. During this loop, display messages should be shown on the vending machines display

VEND SUCCESS/FAILED – 13 02 yy yyh or 13 03h **)

vend is completed

SESSION COMPLETE – 13 04

close session

POLL – 12h

End session

*) only if cashless is used, independent of cashless credit

**) only if cashless payment is done

All answer will be seen in the known format, the new command DRAVS is enabling a cash vend, if the "age valid" (b4 = 1) is set.

11.4 Age Verification Device Command/Response Formats

11.4.1 Reset

RESET (68H)

Reader response:

No Data response

11.4.2 Setup

SETUP (69H)	Config Data (00H) Y1	VMC Feature Level Y2	Columns on Display Y3	Rows On Display Y4	Display Info Y5
----------------	-------------------------------	-------------------------------	--------------------------------	-----------------------------	-----------------------

- Y1 :** Configuration data.
VMC is sending its configuration data to reader.
- Y2 :** VMC Feature Level.
Indicates the feature level of the VMC. The available feature levels are:
01 – the actual used level is 1
- Y3 :** Columns on Display. The number of columns on the display. Set to 00H if the display is not available to the reader.
- Y4 :** Rows on Display.
The number of rows on the display
- Y5 :** Display Information - xxxxyyy
 xxxxx = Unused
 yyy = Display type
 000 : Numbers, upper case letters, blank and decimal point.
 001 : Full ASCII
 010-111: Unassigned

Reader Response:

Reader Config Data (01H) Z1	Reader Feature Level Z2	Country Code High Z3	Country Code Low Z4	Scale Factor Z5	Decimal Places Z6	Application Maximum Response Time Z7	Miscellaneous Options Z8
---	----------------------------------	-------------------------------	------------------------------	-----------------------	-------------------------	--	--------------------------------

- Z1 :** READER - Configuration data.
Indicates the Age Verification Device is responding to a SETUP – Configuration data request from the VMC.

- Z2 :** 01 – the actual used level
- Z3-Z4 :** Country / Currency Code - packed BCD.
The packed BCD country / currency code of the reader can be sent in two different forms depending on the value of the left most BCD digit.
- If the left most digit is a 0, the International Telephone Code is used to indicate the country that the reader is set-up for. For example, the USA code is 00 01H (Z3 = 00 and Z4 = 01).
- If the left most digit is a 1, the latest version of the ISO 4217 numeric currency code is used (see Appendix A1). For example, the code for the US dollar is 18 40H (Z2 = 18 and Z3 = 40) and for the Euro is 19 78 (Z3 = 19 and Z4 = 78). Use FFFFh if the country code is unknown.
- For level 3 cashless readers, it is mandatory to use the ISO 4217 numeric currency code (see Appendix A1).
- Z5 :** Scale Factor.
The multiplier used to scale all monetary values transferred between the VMC and the reader.
- Z6 :** Decimal Places.
The number of decimal places used to communicate monetary values between the VMC and the age verification device.
- All pricing information sent between the VMC and the Age Verification Device is scaled using the scale factor and decimal places. This corresponds to:
- $$\text{ActualPrice} = P \cdot X \cdot 10^{-Y}$$
- where P is the scaled value send in the price bytes, and X is the scale factor, and Y is the number of decimal places. For example if there are 2 decimal places and the scale factor is 5, then a scaled price of 7 will mean an actual of 0.35.
- Z7 :** Application Maximum Response Time - seconds.
The maximum length of time a reader will require to provide a response to any command from the VMC. The value reported here supersedes the payment reader's default NON-RESPONSE time defined in section 7.5 if the value reported here is greater.
- Z8 :** Miscellaneous Options – xxxxyyyy

11.4.3 Poll

POLL
(6AH)

The POLL command is used by the VMC to obtain information from the verification device. In addition to an ACK, the VMC may receive the following POLL responses from the verification device.

Reader responses:

Just
Reset
(00H)
Z1

Z1 : JUST RESET
Indicates the device has been reset.
Note: the difference between ACK and JUST RESET responses is:
00H 00H* =JUST RESET
00H* =ACK
*mode bit=1

Reader Config Info (01H) Z1	Reader Feature Level Z2	Country Code High Z3	Country Code Low Z4	Scale Factor Z5	Decimal Places Z6	Application Maximum Response Time Z7	Miscellaneous Options Z8
--------------------------------	----------------------------	-------------------------	------------------------	--------------------	----------------------	---	-----------------------------

Display Request (02H) Z1	Display Time Z2	Display Data Z3-Z34
-----------------------------	--------------------	------------------------

Z1 : DISPLAY REQUEST
The Age Verification Device is requesting a message to be displayed on the VMC's display.

Z2 : Display Time - 0.1 second units
The requested display time. Either the VMC or the Age Verification Device may overwrite the message before the time has expired.

Peripheral ID (09H) Z1	Manufacturer Code Z2-Z4	Serial Number Z5-Z16	Model Number Z17-Z28	Software Version Z29-Z30	Optional Feature bits Z31 - Z34
---------------------------	----------------------------	-------------------------	-------------------------	-----------------------------	------------------------------------

- Z1 :** PERIPHERAL ID
Age Verification Device is sending peripheral ID information.
- Z2 - Z4 :** Manufacturer Code - ASCII
Identification code for the equipment supplier. Currently defined codes are listed in the **EVA** document entitled "**European Vending Association Data Transfer Standard**" (**EVA-DTS**), the Audit Data Lists section, sub-section 2, "Manufacturer Codes".
- Z5-Z16 :** Serial Number – ASCII
Factory assigned serial number.
- Z17-Z28 :** Model Number - ASCII
Manufacturer assigned model number.
- Z29-Z30 :** Software Version - packed BCD
Current software version.
- Z31- Z34** Optional Feature Bits. Each of the 32 bits indicate an optional feature availability. Bits should be sent in descending order, i.e. bit 31 is sent first and bit 0 is sent last. Options **must be enabled by the VMC** using the Expansion Optional Feature Bit Enable (17H-04H) command and **all features are disabled after a reset**. Currently defined options are:
 - b0 - File Transport Layer supported
 - b1 to b31 not used (should be set to 0)

Malfunction / Error	Error Code
(0AH) Z1	Z2

- Z1 :** MALFUNCTION/ERROR
The Age Verification Device is reporting a malfunction or error.
- Z2 :** Error Code - xxxxyyyy

Transient Error Handling

The error will be reported to the VMC until it has been ACKnowledged. The error state will be cleared in the age verification device, and normal operations will continue.

Non-transient Error Handling

The error will be reported to the VMC at each POLL as long as it exists. If the Age Verification Device is still functional, multi-message responses will allow normal responses in addition to the error report.

Time/Date Request (11H)

Z1

Z1 : TIME DATE REQUEST

In certain circumstances it will be necessary to synchronize the real time clock of the Age Verification Device with real time clock of the VMC. The Age Verification Device will respond with TIME/DATE REQUEST to a POLL command of the VMC. The VMC will follow with the EXPANSION-WRITE TIME/DATE FILE to the age verification device.

11.4.4 Expansion commands (request ID)

Expansion (6FH)	Request ID (00H)	Manufacturer Code	Serial Number	Model Number	Software Version
	Y1	Y2-Y4	Y5-Y16	Y17-Y28	Y29-Y30

Y1 : REQUEST ID

The VMC is requesting Age Verification Device identification information. The information included above (Y2-Y30) provides the Age Verification Device with VMC identification information.

Y2-Y4 : Manufacturer Code - ASCII

Identification code for the equipment supplier. Currently defined codes are listed in the EVA document entitled "The Data Transfer Standard EVA-DTS" document, the Audit Data Dictionary section, chapter 4, "Manufacturer Codes".

Y5-Y16 : Serial Number - ASCII

Factory assigned serial number.

Y17-Y28 : Model Number - ASCII

Manufacturer assigned model number.

Y29-Y30 : Software Version - packed BCD

Current software version.

Age Verification Device response:

Peripheral ID (09H)	Manufacture Code	Serial Number	Model Number	Software Version	Optional Feature Bits
Z1	Z2-Z4	Z5-Z16	Z17-Z28	Z29-Z30	Z31-Z34

11.4.5 EXPANSION - Write Time/Date File

Expansion (6FH)	Write Time/ Date File (03H) Y1	Time Date Y2-Y11
--------------------	---	------------------------

- Y1 :** WRITE TIME/DATE FILE
The VMC requests to write the Time/Date file.
- Y2- Y11:** Time/Date to synchronize the Age Verification Device real time clock. The date bytes are BCD encoded.
- Y2 = Years (Range: 00..99)
 - Y3 = Months (Range: 01..12)
 - Y4 = Days (Range: 01..31)
 - Y5 = Hours (Range: 00..23)
 - Y6 = Minutes (Range: 00..59)
 - Y7 = Seconds (Range: 00..59)
 - Y8 = Day of Week (Range: 01..07, Monday = 1..Sunday = 7)
 - Y9 = Week Number (Range: 01..53)
 - Y10 = Summertime (Range: 00..01, Summertime = 1)
 - Y11 = Holiday (Range: 00..01, Holiday = 1)
- If any item of the time/date is not supported use FFH instead.

11.4.6 EXPANSION - Diagnostics

Expansion (6FH)	Diagnostics (FFH) Y1	User Defined Data Y2-Yn
--------------------	----------------------------	----------------------------------

- Y1 :** DIAGNOSTICS.
Device manufacturer specific instruction for implementing various manufacturing or test modes.
- Y2-Yn :** User Defined Data.
The data portion of this command is defined by the manufacturer and is not part of this document.

Age Verification Device response:

Diagnostics Response (FFH) Z1	User Defined Z2-Zn
--	--------------------------

- Z1 :** DIAGNOSTICS RESPONSE.
- Z2-Zn :** User Defined Data.
The data portion of this response is defined by the manufacturer and is not part of this document.

11.5 Age Verification Device Non-Response Time

The default maximum non-response time for the Age Verification Device is 5 seconds. This is the maximum time for which an Age Verification Device will not respond to a command or a POLL with ACK, NAK or a message. The “Application Maximum Response Time” reported in byte Z7 of the Age Verification Device Configuration Data supersedes this default value if Z7 is greater.

11.6 Age Verification Device Power Requirements

The current draw for any Age Verification Device must fall within the following limits. All measurements are at the minimum VMC Voltage Output.

Idle mode = 300 mA. (avg.) continuous

Transport or Read/Write cycle = 1.5 A @ 50% maximum duty cycle up to 5 seconds.

Appendix 1

Currency Codes

A1.1 Information

The following **Tables of Codes for the Representation of Currencies and Funds** are provided by the Secretariat of ISO 4217 MA. It is provided here to be used for the MDB currency code information sent between the credit peripherals and the VMC.

Table A.1 Currency and Funds Code List (English alphabetical order by entity)

Table A.2 Funds Codes Registered with the Maintenance Agency

Table A.3 Codes for Historic Denominations of Currencies and Funds

A1.2 MDB/ICP Use

As stated in the individual credit device sections, the two byte, packed BCD country / currency code of the coin changer, bill validator, and card reader devices can be sent in two different forms depending on the value of the left most BCD digit.

If the left most digit is a 0, the International Telephone Code is used to indicate the country that the reader is set-up for.

For example, the USA telephone code is 001 which translates into the MDB code as **00 01h** (Zx = **00h** and Zy = **01h**).

If the left most digit is a 1, the latest version of the ISO 4217 numeric currency code is used as listed in this Appendix.

For example, the code for the US dollar is 840 which translates into the MDB code as **18 40h** (Zx = **18h** and Zy = **40h**).

The code for the Euro is 978 which translates into the MDB code as **1978h** (Zx = **19h** and Zy = **78h**).

FFFFh should be used if the country code is unknown (Zx = **FFh** and Zy = **FFh**).

Note that for level 3 cashless readers, it is mandatory to use the the ISO 4217 numeric currency code.

Table A.1 Currency and Funds Code List (English alphabetical order by entity)

ENTITY	Currency	Code		Decimal Position
		Alphabetic	Numeric	
AFGHANISTAN	Afghani	AFA	004	2
ALBANIA	Lek	ALL	008	2
ALGERIA	Algerian Dinar	DZD	012	2
AMERICAN SAMOA	US Dollar	USD	840	2
ANDORRA	Spanish Peseta	ESP	724	0
	French Franc	FRF	250	2
	Andorran Peseta	ADP	020	0
ANGOLA	New Kwanza	AON	024	2
	Kwanza Reajustado	AOR	982	2
ANGUILLA	East Caribbean Dollar	XCD	951	2
ANTARCTICA	No universal currency			
ANTIGUA AND BARBUDA	East Caribbean Dollar	XCD	951	2
ARGENTINA	Argentine Peso	ARS	032	2
ARMENIA	Armenian Dram	AMD	051	2
ARUBA	Aruban Guilder	AWG	533	2
AUSTRALIA	Australian Dollar	AUD	036	2
AUSTRIA	Schilling	ATS	040	2
AZERBAIJAN	Azerbaijani Manat	AZM	031	2
BAHAMAS	Bahamian Dollar	BSD	044	2
BAHRAIN	Bahraini Dinar	BHD	048	3
BANGLADESH	Taka	BDT	050	2
BARBADOS	Barbados Dollar	BBD	052	2
BELARUS	Belarussian Ruble	BYB	112	0
	Belarussian Ruble	BYR	974	0
BELGIUM	Belgian Franc	BEF	056	0
BELIZE	Belize Dollar	BZD	084	2
BENIN	CFA Franc BCEAO+	XOF	952	0
BERMUDA	Bermudian Dollar	BMD	060	2
	(customarily known as Bermuda Dollar)			
BHUTAN	Indian Rupee	INR	356	2
	Ngultrum	BTN	064	2

+ CFA Franc BCEAO; Responsible authority: Banque Centrale des Etats de l'Afrique de l'Ouest.

Table A.1 (Continued)

ENTITY	Currency	Code		Decimal Position
		Alphabetic	Numeric	
BOLIVIA	Boliviano	BOB	068	2
	Mvdol*	BOV	984	2
BOSNIA & HERZEGOVINA	Convertible Marks	BAM	977	2
BOTSWANA	Pula	BWP	072	2
BOUVET ISLAND	Norwegian Krone	NOK	578	2
BRAZIL	Brazilian Real	BRL	986	2
BRITISH INDIAN OCEAN TERRITORY	US Dollar	USD	840	2
BRUNEI DARUSSALAM	Brunei Dollar	BND	096	2
BULGARIA	Lev	BGL	100	2
	Bulgarian LEV	BGN	975	2
BURKINA FASO	CFA Franc BCEAO+	XOF	952	0
BURUNDI	Burundi Franc	BIF	108	0
CAMBODIA	Riel	KHR	116	2
CAMEROON	CFA Franc BEAC#	XAF	950	0
CANADA	Canadian Dollar	CAD	124	2
CAPE VERDE	Cape Verde Escudo	CVE	132	2
CAYMAN ISLANDS	Cayman Islands Dollar	KYD	136	2
	CFA Franc BEAC#	XAF	950	0
CENTRAL AFRICAN REPUBLIC	CFA Franc BEAC#	XAF	950	0
CHAD	CFA Franc BEAC#	XAF	950	0
CHILE	Chilean Peso	CLP	152	0
	Unidades de fomento*	CLF	990	0
CHINA	Yuan Renminbi	CNY	156	2
CHRISTMAS ISLAND	Australian Dollar	AUD	036	2
COCOS (KEELING) ISLANDS	Australian Dollar	AUD	036	2
COLOMBIA	Colombian Peso	COP	170	2
COMOROS	Comoro Franc	KMF	174	0

+ CFA Franc BCEAO; Responsible authority: Banque Centrale des Etats de l'Afrique de l'Ouest.

CFA Franc BEAC; Responsible authority: Banque des Etats de l'Afrique Centrale.

• Funds code [See table A.2(E) for definitions of funds types].

Table A.1 (Continued)

ENTITY	Currency	Code		Decimal Position
		Alphabetic	Numeric	
CONGO	CFA Franc BEAC#	XAF	950	0
CONGO, THE DEMOCRATIC REPUBLIC OF	Franc Congolais	CDF	976	2
COOK ISLANDS	New Zealand Dollar	NZD	554	2
COSTA RICA	Costa Rican Colon	CRC	188	2
COTE D'IVOIRE	CFA Franc BCEAO+	XOF	952	0
CROATIA	Kuna	HRK	191	2
CUBA	Cuban Peso	CUP	192	2
CYPRUS	Cyprus Pound	CYP	196	2
CZECH REPUBLIC	Czech Koruna	CZK	203	2
DENMARK	Danish Krone	DKK	208	2
DJIBOUTI	Djibouti Franc	DJF	262	0
DOMINICA	East Caribbean Dollar	XCD	951	2
DOMINICAN REPUBLIC	Dominican Peso	DOP	214	2
EAST TIMOR	Timor Escudo	TPE	626	0
	Rupiah	IDR	360	2
ECUADOR	US Dollar	ESD	840	2
EGYPT	Egyptian Pound	EGP	818	2
EL SALVADOR	El Salvador Colon	SVC	222	2
EQUATORIAL GUINEA	CFA Franc BEAC#	XAF	950	0
ESTONIA	Kroon	EEK	233	2
ERITREA	Nakfa	ERN	232	2
ETHIOPIA	Ethiopian Birr	ETB	230	2
FAEROE ISLANDS	Danish Krone	DKK	208	2
FALKLAND ISLANDS (MALVINAS)	Falkland Islands Pound	FKP	238	2

CFA Franc BEAC; Responsible authority: Banque des Etats de l'Afrique Centrale.

+ CFA Franc BCEAO; Responsible authority: Banque Centrale des Etats de l'Afrique de l'Ouest.

* Funds code [see Table A.2 (E) for definitions of funds types].

Table A.1 (Continued)

ENTITY	Currency	Code		Decimal Position
		Alphabetic	Numeric	
FIJI	Fiji Dollar	FJD	242	2
FINLAND	Markka	FIM	246	2
FRANCE	French Franc	FRF	250	2
FRENCH GUIANA	French Franc	FRF	250	2
FRENCH POLYNESIA	CFP Franc	XPF	953	0
FRENCH SOUTHERN TERRITORIES	French Franc	FRF	250	2
GABON	CFA Franc BEAC#	XAF	950	0
GAMBIA	Dalasi	GMD	270	2
GEORGIA	Lari	GEL	981	2
GERMANY	Deutsche Mark	DEM	276	2
GHANA	Cedi	GHC	288	2
GIBRALTAR	Gibraltar Pound	GIP	292	2
GREECE	Drachma	GRD	300	2
GREENLAND	Danish Krone	DKK	208	2
GRENADA	East Caribbean Dollar	XCD	951	2
GUADELOUPE	French Franc	FRF	250	2
GUAM	US Dollar	USD	840	2
GUATEMALA	Quetzal	GTQ	320	2
GUINEA	Guinea Franc	GNF	324	0
GUINEA-BISSAU	Guinea-Bissau Peso	GWP	624	2
	CFA Franc BCEAO+	XOF	952	0
GUYANA	Guyana Dollar	GYD	328	2
HAITI	Gourde	HTG	332	2
	US Dollar	USD	840	2
HEARD AND MCDONALD ISLANDS	Australian Dollar	AUD	036	2
HONDURAS	Lempira	HNL	340	2

CFA Franc BEAC; Responsible authority: Banque des Etats de l'Afrique Centrale.

+ CFA Franc BCEAO; Responsible authority: Banque Centrale des Etats de l'Afrique de l'Ouest.

Table A.1 (Continued)

ENTITY	Currency	Code		Decimal Point
		Alphabetic	Numeric	
HONG KONG	Hong Kong Dollar	HKD	344	2
HUNGARY	Forint	HUF	348	2
ICELAND	Iceland Krona	ISK	352	2
INDIA	Indian Rupee	INR	356	2
INDONESIA	Rupiah	IDR	360	2
INTERNATIONAL MONETARY FUND (IMF)**	SDR	XDR	960	N.A.
IRAN (ISLAMIC REPUBLIC OF)	Iranian Rial	IRR	364	2
IRAQ	Iraqi Dinar	IQD	368	3
IRELAND	Irish Pound	IEP	372	2
ISRAEL	New Israeli Sheqel*	ILS	376	2
ITALY	Italian Lira	ITL	380	0
JAMAICA	Jamaican Dollar	JMD	388	2
JAPAN	Yen	JPY	392	0
JORDAN	Jordanian Dinar	JOD	400	3
KAZAKHSTAN	Tenge	KZT	398	2
KENYA	Kenyan Shilling	KES	404	2
KIRIBATI	Australian Dollar	AUD	036	2
KOREA, DEMOCRATIC PEOPLE'S REPUBLIC OF	North Korean Won	KPW	408	2
KOREA, REPUBLIC OF	Won	KRW	410	0

* Currency name was effective 4th September 1985

** This entry is not derived from ISO 3166, but is included here in alphabetic sequence for convenience.

Table A.1 (Continued)

ENTITY	Currency	Code		Decimal Point
		Alphabetic	Numeric	
KUWAIT	Kuwaiti Dinar	KWD	414	3
KYRGYZSTAN	Som	KGS	417	2
LAO PEOPLE'S DEMOCRATIC REPUBLIC	Kip	LAK	418	2
LATVIA	Latvian Lats	LVL	428	2
LEBANON	Lebanese Pound	LBP	422	2
LESOTHO	Rand	ZAR	710	2
	(financial Rand)*	ZAL	991	2
	Loti	LSL	426	2
LIBERIA	Liberian Dollar	LRD	430	2
LIBYAN ARAB JAMAHIRIYA	Libyan Dinar	LYD	434	3
LIECHTENSTEIN	Swiss Franc	CHF	756	2
LITHUANIA	Lithuanian Litas	LTL	440	2
LUXEMBOURG	Luxembourg Franc	LUF	442	0
MACAU	Pataca	MOP	446	2
MACEDONIA, THE FORMER YUGOSLAV REPUBLIC OF	Denar	MKD	807	2
MADAGASCAR	Malagasy Franc	MGF	450	0
MALAWI	Kwacha	MWK	454	2
MALAYSIA	Malaysian Ringgit	MYR	458	2
MALDIVES	Rufiyaa	MVR	462	2
MALI	CFA Franc BCEAO+	XOF	952	0
MALTA	Maltese Lira	MTL	470	2
MARSHALL ISLANDS	US Dollar	USD	840	2
MARTINIQUE	French Franc	FRF	250	2
MAURITANIA	Ouguiya	MRO	478	2
MAURITIUS	Mauritius Rupee	MUR	480	2
MEXICO	Mexican Peso	MXN	484	2
	Mexican Unidad de Inversion (UDI)*	MXV	979	2
MICRONESIA	US Dollar	USD	840	2
MOLDOVA, REPUBLIC OF	Moldovan Leu	MDL	498	2
MONACO	French Franc	FRF	250	2

* Funds code [See table A.2(E) for definitions of funds types].

+ CFA Franc BCEAO; Responsible authority: Banque Centrale des Etats de l'Afrique de l'Ouest.

Table A.1 (Continued)

ENTITY	Currency	Code		Decimal Point
		Alphabetic	Numeric	
MONGOLIA	Tugrik	MNT	496	2
MONTSERRAT	East Caribbean Dollar	XCD	951	2
MOROCCO	Moroccan Dirham	MAD	504	2
MOZAMBIQUE	Metical	MZM	508	2
MYANMAR	Kyat	MMK	104	2
NAMIBIA	Rand	ZAR	710	2
	Namibia Dollar**	NAD	516	2
NAURU	Australian Dollar	AUD	036	2
NEPAL	Nepalese Rupee	NPR	524	2
NETHERLANDS	Netherlands Guilder	NLG	528	2
NETHERLANDS ANTILLES	Netherlands Antillian Guilder	ANG	532	2
NEW CALEDONIA	CFP Franc	XPF	953	0
NEW ZEALAND	New Zealand Dollar	NZD	554	2
NICARAGUA	Cordoba Oro	NIO	558	2
NIGER	CFA Franc BCEAO+	XOF	952	0
NIGERIA	Naira	NGN	566	2
NIUE	New Zealand Dollar	NZD	554	2
NORFOLK ISLAND	Australian Dollar	AUD	036	2
NORTHERN MARIANA ISLANDS	US Dollar	USD	840	2
NORWAY	Norwegian Krone	NOK	578	2
OMAN	Rial Omani	OMR	512	3
PAKISTAN	Pakistan Rupee	PKR	586	2
PALAU	US Dollar	USD	840	2

+ CFA Franc BCEAO; Responsible authority: Banque Centrale des Etats de l'Afrique de l'Ouest.

The lowest unit of recorded value for the Iraqi Dinar is the Dirham (1 Iraqi Dinar = 20 Dirhams).

** The Namibia Dollar becomes effective September 15th 1993

Table A.1 (Continued)

ENTITY	Currency	Code		Decimal Point
		Alphabetic	Numeric	
PANAMA	Balboa	PAB	590	2
	US Dollar	USD	840	2
PAPUA NEW GUINEA	Kina	PGK	598	2
PARAGUAY	Guarani	PYG	600	0
PERU	Nuevo Sol	PEN	604	2
PHILIPPINES	Philippine Peso	PHP	608	2
PITCAIRN	New Zealand Dollar	NZD	554	2
POLAND	Zloty	PLN	985	2
PORTUGAL	Portuguese Escudo	PTE	620	0
PUERTO RICO	US Dollar	USD	840	2
QATAR	Qatari Rial	QAR	634	2
REUNION	French Franc	FRF	250	2
ROMANIA	Leu	ROL	642	2
RUSSIAN FEDERATION	Russian Ruble	RUR	810	2
	Russian Ruble	RUB	643	2
RWANDA	Rwanda Franc	RWF	646	0
ST HELENA	St Helena Pound	SHP	654	2
ST KITTS - NEVIS	East Caribbean	XCD	951	2
	Dollar			
SAINT LUCIA	East Caribbean	XCD	951	2
	Dollar			
ST PIERRE AND MIQUELON	French Franc	FRF	250	2
SAINT VINCENT AND THE GRENADINES	East Caribbean	XCD	951	2
	Dollar			
SAMOA	Tala	WST	882	2
SAN MARINO	Italian Lira	ITL	380	0
SAO TOME AND PRINCIPE	Dobra	STD	678	2
SAUDI ARABIA	Saudi Riyal	SAR	682	2

Table A.1 (Continued)

ENTITY	Currency	Code		Decimal Point
		Alphabetic	Numeric	
SENEGAL	CFA Franc BCEAO+	XOF	952	0
SEYCHELLES	Seychelles Rupee	SCR	690	2
SIERRA LEONE	Leone	SLL	694	2
SINGAPORE	Singapore Dollar	SGD	702	2
SLOVAKIA	Slovak Koruna	SKK	703	2
SLOVENIA	Tolar	SIT	705	2
SOLOMON ISLANDS	Solomon Islands Dollar	SBD	090	2
SOMALIA	Somali Shilling	SOS	706	2
SOUTH AFRICA	Rand	ZAR	710	2
SPAIN	Spanish Peseta	ESP	724	0
SRI LANKA	Sri Lanka Rupee	LKR	144	2
SUDAN	Sudanese Dinar	SDD	736	2
SURINAME	Surinam Guilder	SRG	740	2
SVALBARD AND JAN MAYEN ISLANDS	Norwegian Krone	NOK	578	2
SWAZILAND	Lilangeni	SZL	748	2
SWEDEN	Swedish Krona	SEK	752	2
SWITZERLAND	Swiss Franc	CHF	756	2
SYRIAN ARAB REPUBLIC	Syrian Pound	SYP	760	2
TAIWAN, PROVINCE OF CHINA	New Taiwan Dollar	TWD	901	2
TAJIKISTAN	Tajik Ruble	TJR	762	0

+ CFA Franc BCEAO; Responsible authority: Banque Centrale des Etats de l'Afrique de l'Ouest.

Table A.1 (Continued)

ENTITY	Currency	Code		Decimal Point
		Alphabetic	Numeric	
TANZANIA, UNITED REPUBLIC OF	Tanzanian Shilling	TZS	834	2
THAILAND	Baht	THB	764	2
TOGO	CFA Franc BCEAO+	XOF	952	0
TOKELAU	New Zealand Dollar	NZD	554	2
TONGA	Pa'anga	TOP	776	2
TRINIDAD AND TOBAGO	Trinidad and Tobago Dollar	TTD	780	2
TUNISIA	Tunisian Dinar	TND	788	3
TURKEY	Turkish Lira	TRL	792	0
TURKMENISTAN	Manat	TMM	795	2
TURKS AND CAICOS ISLANDS	US Dollar	USD	840	2
TUVALU	Australian Dollar	AUD	036	2
UGANDA	Uganda Shilling ++	UGX	800	0
UKRAINE	Hryvnia	UAH	980	2
UNITED ARAB EMIRATES	UAE Dirham	AED	784	2
UNITED KINGDOM	Pound Sterling	GBP	826	2
UNITED STATES	US Dollar	USD	840	2
	(Same day)*	USS	998	2
	(Next day)*	USN	997	2
UNITED STATES MINOR OUTLAYING ISLANDS	US Dollar	USD	840	2

+ CFA Franc BCEAO; Responsible authority: Banque Centrale des Etats de l'Afrique de l'Ouest.

++ The Uganda Shilling was denominated as from 18 May 1987.

* Funds code [See table A.2(E) for definitions of funds types].

Table A.1 (Continued)

ENTITY	Currency	Code		Decimal Point
		Alphabetic	Numeric	
URUGUAY	Peso Uruguayo	UYU	858	2
UZBEKISTAN	Uzbekistan Sum	UZS	860	2
VANUATU	Vatu	VUV	548	0
VATICAN CITY STATE (HOLY SEE)	Italian Lira	ITL	380	0
VENEZUELA	Bolivar	VEB	862	2
VIETNAM	Dong	VND	704	2
VIRGIN ISLANDS (BRITISH)	US Dollar	USD	840	2
VIRGIN ISLANDS (U.S.)	US Dollar	USD	840	2
WALLIS AND FUTUNA ISLANDS	CFP Franc	XPF	953	0
WESTERN SAHARA	Moroccan Dirham	MAD	504	2
YEMEN	Yemeni Rial	YER	886	2
YUGOSLAVIA	New Dinar	YUM	891	2
ZAMBIA	Kwacha	ZMK	894	2
ZIMBABWE	Zimbabwe Dollar	ZWD	716	2

Table A.1 (Continued)

ENTITY	Currency	Code		Decimal Position
		Alphabetic	Numeric	
Entity not applicable	Gold	XAU	959	N.A.
	Bond Markets Units			
	European Composite Unit (EURCO)	XBA	955	N.A.
	European Monetary Unit (E.M.U.-6)***	XBB	956	N.A.
	European Unit of Account 9 (E.U.A.- 9)	XBC	957	N.A.
	European Unit of Account 17 (E.U.A.- 17)	XBD	958	N.A.
	Palladium	XPD	964	N.A.
	Platinum	XPT	962	N.A.
	Silver	XAG	961	N.A.

*** E.M.U.-6 is sometimes known as the European Currency Unit. This should not be confused with the settlement unit of the European Monetary Cooperation Fund (E.M.C.F.) which has the same name (see entry for 'European Monetary Cooperation Fund' in this table).

Table A.1 (Continued)

ENTITY	Currency	Code		Decimal Position
		Alphabetic	Numeric	
Entity not applicable	Special settlement currencies			
	UIC-Franc	XFU	Nil	N.A.
	Gold-Franc	XFO	Nil	N.A.
	Codes specifically reserved for testing purposes	XTS	963	N.A.
	The codes assigned for transactions where no currency is involved are:	XXX	999	N.A.
euro*	EUR*	978	2	

* On 1 January 1999, the euro will become the currency of those Member States of the European Union which adopt the single currency in accordance with the Treaty establishing the European Community. This code has been issued now so that technical preparations can be started. The code element "EU" has been reserved by the ISO 3166 Maintenance Agency for use within ISO 4217 where "R" has been appended to make an acceptable mnemonic code.

Table A.2 Funds Codes Registered with the Maintenance Agency

CURRENCY AUTHORITY	Currency	Fund Type	Code		Decimal Position
			Alphabetic	Numeric	
BOLIVIA		Mvdol	BOV	984	2
CHILE		Unidades de Fomento	CLF	990	0
MEXICO		Mexican Unidad de Inversion (UDI)	MXV	979	2
UNITED STATES	US Dollar	Same day	USS	998	2
		Next day	USN	997	2

Definitions of the fund types listed above

BOV: For indexation purposes and denomination of certain financial instruments (ex. treasury bills). The Mvdol is set daily by the Central Bank of Bolivia based upon the official USD/BOB rate.

CLF: This development unit has been approved by the Chilean government for use in insurance transactions (with effect from 10 April 1980).

ECV: A daily indexation mechanism set by the Ecuadorian Central Bank. The UVC is set according to the variation of the Consumer price Index (Urban), as compiled by the National Census and Statistics Institute (INEC).

MXV : The UDI is an inflation adjusted mechanism set by the Central Bank of Mexico according to the variation in the Mexican Consumer Price Index. The value of the UDI is expressed in terms of Mexican Pesos per UDI. It is used to denominate mortgage loans, some bank deposits with maturities of 3 month or more and Government bonds (UDIBONOS).

USN: "Next day" funds are immediately available for transfer in like funds, and subject to settlement, available the next business day for same day funds transfer or withdrawal in cash.

USS: "Same day" funds are immediately available for transfer today or for withdrawal in cash, subject to the settlement of the transaction through the payment mechanism used.

(USD designates the US Dollar, the currency designator when an accumulation of amounts contains more than one funds type.)

Table A.3 Codes for Historic Denomination of Currencies and Funds

ENTITY	Historic Currencies	Code	Numeric	WD
ALBANIA	Old Lek	ALK *	-	12/89
ANGOLA	Kwanza	AOK	-	03/91
ARGENTINA	Peso Argentino	ARP	-	07/85
	Austral	ARA	-	01/92
	Peso	ARY*	-	1989/1990
BELGIUM	Convertible Franc	BEC	993	03/90
	Financial Franc	BEL	992	03/90
BOLIVIA	Peso	BOP	-	02/87
BOSNIA & HERZEGOVINA	Dinar	BAD	070	09/97
BRAZIL	Cruzeiro	BRB	-	03/86
	Cruzado	BRC	-	02/89
	New Cruzado	BRN	-	03/90
	Cruzeiro	BRE	076	08/93
	Cruzeiro Real	BRR	987	07/94
BULGARIA	Lev A/62	BGK*	-	1989/1990
	Lev A/52	BGJ*	-	1989/1990
BURMA#	N/A	BUK	-	02/90
CHINA	Peoples Bank Dollar	CNX*	-	12/89
CROATIA	Dinar	HRD	-	01/95
CZECHOSLOVAKIA	Krona A/53	CSJ*	-	1989/1990
	Koruna	CSK	200	03/93
ECUADOR	Sucre	ECS	218	9/00
	Unidad del Valor constante (UVC)*	ECV	983	9/00
EQUATORIAL GUINEA	Ekwele	GQE	226	06/86
	Ekwele	EQE*	-	12/89

* Non ISO code

Change in country name

Table 3 (Continued)

ENTITY	Historic Currencies	Code	Numeric	WD
EUROPEAN MONETARY COOPERATION FUND (EMCF)**	European Currency Unit (E.C.U)	XEU	954	01/99
GERMAN DEMOCRATIC REPUBLIC	Mark der DDR	DDM	278	07/90 to 09/90
GEORGIA	Georgian Coupon	GEK	268	10/95
GUINEA	Syli	GNS	-	02/86
	Syli	GNE*	-	12/89
GUINEA BISSAU	Guinea Escudo	GWE	-	Between 1978-1981
ICELAND	Old Krona	ISJ*	-	1989/1990
ISRAEL	Old Shekel	ILR*	-	1989/1990
	Pound	ILP	-	Between 1978-1981
LESOTHO	Maloti	LSM	-	05/85
LAO	Kip Pot Pol	LAJ*	-	12/89
LATVIA	Latvian Ruble	LVR	-	12/94
LITHUANIA	Talonas	LTT	-	07/93
LUXEMBOURG	Convertible Franc	LUC	989	03/90
	Financial Franc	LUL	988	03/90
MALDIVES	Maldive Rupee	MVQ*	-	12/89
MALI	Mali Franc	MAF*	-	12/89
		MLF	446	11/84
MALTA	Maltese Pound	MTP	-	06/83
MEXICO	Mexican Peso	MXP	-	01/93

* Non ISO code

Table 3 (Continued)

ENTITY	Historic Currencies	Code	Numeric	WD
MOZAMBIQUE	Mozambique Escudo	MZE	-	Between 1978-1981
NICARAGUA	Cordoba	NIC	-	10/90
PERU	Sol	PES	-	02/86
	Inti	PEI	-	07.91
	Sol	PEH*	-	1989/1990
POLAND	Zloty	PLZ	616	01/97
ROMANIA	Leu A/52	ROK*	-	1989/1990
SOUTH AFRICA	Financial Rand	ZAL	991	03/95
SOUTHERN RHODESIA#	Rhodesian Dollar	RHD	-	Between 1978-1981
SPAIN	Spanish Peseta ("A" Account)	ESA	996	Between 1981-1983
	(convertible Peseta Accounts)	ESB	995	12/94
SUDAN	Sudanese Pound	SDP	-	06/98
UNION OF SOVIET SOCIALIST REPUBLICS#	Rouble	SUR	-	12/90
YEMEN, DEMOCRATIC OF	Yemeni Dinar	YDD	720	09/91
UGANDA	Uganda Shilling	UGS	-	05/87
	Old Shilling	UGW*	-	1989/1990
UKRAINE	Karbovanet	UAK	804	09/96

* Non ISO code

Change in country name.

Table 3 (Continued)

ENTITY	Historic Currencies	Code	Numeric	WD
URUGUAY	Old Uruguay Peso	UYN*	-	12/89
	Uruguayan Peso	UYP	-	03/93
VIETNAM	Old Dong	VNC*	-	1989/1990
YUGOSLAVIA	New Yugoslavian Dinar	YUD	-	01/90
	Yugoslavian Dinar	YUN	890	11/95
ZAIRE	Zaire	ZRZ	-	02/94
	New Zaire	ZRN	180	06/99
ZIMBABWE	Rhodesian Dollar	ZWC*	-	12/89
ENTITY AND CURRENCY NOT APPLICABLE	RINET Funds Code	XRE	N/A	11/99

* Non ISO code

ANNEX

INFORMATION TO BE PROVIDED BY THOSE MAKING APPLICATION FOR THE ISSUE OF NEW CODES, AMENDMENTS AND DELETIONS.

Applications for additions or changes to the code lists are acceptable from any source. However, in order to ensure rapid processing by the Secretaries, the information required from applicants has been laid down as follows:

- (a) Name of entity
- (b) Name of currency
- (c) The institution responsible for the currency (name and place of operation).
- (d) Requirements:
 - (1) Whether currency or funds code: if funds code, give definition and proposed use;
 - (2) If new code, make proposal;
 - (3) If revision, state existing code and make proposal;
 - (4) If deletion, indicate code to be deleted;
- (e) Reason for application;
- (f) Evidence of support (currency code only);
- (g) Date of implementation (indicate if special conditions of urgency apply);
- (h) Application submitted by (name, address, telephone, telex numbers, etc, of applicant);
- (i) Date of application.

Applications should be addressed to

Miss A M Wadsworth	Tel. (0181) 996 7466 National
Secretariat for ISO4217MA	+44 181 996 7466 International
BSI	
389 Chiswick High Road	Fax (0181) 996 7466 National
London	+44 181 996 7466 International
W4 4AL United Kingdom	

Appendix 2

Battery Operated Card Reader

A2.1 Special Application

The Battery Operated Card Reader described below is a special application of the MDB/ICP specification (non-standard) and is not sanctioned by NAMA. It is provided here to document an application that exists in use today.

A2.2 Extension to MDB/ICP – Card Reader Using Standby Feature

Some Vending machines use battery operated equipment. According to this feature, these machines and all devices used within these machines must provide a standby operating mode.

During standby operation - necessary for saving battery power while the machine is not in use - all devices shall consume a minimum standby current. Any device is equipped with some hardware wake-up mechanism. Both standby current and wake-up mechanism is to be defined in the device related hardware specification.

After wake-up, a device uses normal operating current, until a defined shutdown sequence is established and the device enters standby mode again.

The following specification shows the extensions and procedures for a normal MDB/ICP card reader and VMC-controller necessary to do wake-up and shut down sequences. The hardware specification related to wake-up is a separate BDTA-document. To understand the following details, it is necessary to know, that a separate bi-directional wake-up pin is applied to the card-reader. Pulling the wake-up line (from the card-reader while a card is inserted), both card-reader and VMC will be brought to normal operation mode.

A2.3 Extension to MDB/ICP – SETUP Config Data

SETUP (11H)	Config Data (00H) Y1	VMC Feature Level Y2	Columns on Display Y3	Rows on Display Y4	Display Info Y5
----------------	-------------------------------	-------------------------------	--------------------------------	-----------------------------	-----------------------

Y1 : Configuration data.

VMC is sending its configuration data to reader.

Y2 : VMC Feature Level.

Indicates the feature level of the VMC. The available feature levels are:

01 - The VMC is not capable or will not perform the advanced features as specified in [Table 1: COMMANDS & RESPONSES](#) following Section 7.3.2. The reader will not provide advanced information to the VMC, but can do the advanced features internally (transparently to the VMC). The reader has no revaluation capability.

02 - The VMC is capable and willing to perform the advanced features as specified in [Table 1: COMMANDS & RESPONSES](#) following Section 7.3.2. The reader will provide advanced information to the VMC (if possible) and will not do the advanced features internally.

03 - The VMC is able to support level 02, but also supports some or all of the optional features listed in the EXPANSION ID command (i.e., file transfer, 32 bit credit, multi-currency / language features, negative vend, and / or data entry).

81H: VMC is Level 01, but battery operated.

82H: VMC is Level 02, but battery operated.

83H: VMC is Level 03, but battery operated.

Y3 : Columns on Display. The number of columns on the display. Set to 00H if the display is not available to the reader.

Y4 : Rows on Display.
The number of rows on the display.

Y5 : Display Information - xxxxyyy
 xxxxx = Unused
 yyy = Display type
 000 : Numbers, upper case letters, blank and decimal point.
 001 : Full ASCII
 010-111: Unassigned

Reader Config Data (01H)	Reader Feature Level	Country / Currency Code High	Country / Currency Code Low	Scale Factor	Decimal Places	Application Maximum Response Time	Miscellaneous Options
Z1	Z2	Z3	Z4	Z5	Z6	Z7	Z8

Z1 : READER - Configuration data.
Indicates the payment media reader is responding to a SETUP - Configuration data request from the VMC.

Z2 : Reader Feature Level.
Indicates the feature level of the reader. Currently feature levels are:

01 - The reader is not capable or will not perform the advanced features as specified in [Table 1: COMMANDS & RESPONSES](#) following Section 7.3.2. The reader will not provide advanced information to the VMC, but can do the advanced features internally (transparently to the VMC). The reader has no revaluation capability.

02 - The reader is capable and willing to perform the advanced features as specified in [Table 1: COMMANDS & RESPONSES](#) following Section 7.3.2. The reader will provide advanced information to the VMC (if possible) and will not do the advanced features internally.

03 - The reader is able to support level 02, but also supports some or all of the optional features listed in the EXPANSION ID command (i.e., file transfer, 32 bit credit, multi-currency / language features, negative vend, and / or data entry).

80H: This bit is additionally set, if the reader is capable to work in battery operation mode and should be compared with the VMC against its own working mode. This is also done from the reader against the VMCs request in Y2.

Z3-Z4 : Country / Currency Code - packed BCD.
The packed BCD country / currency code of the changer can be sent in two different forms depending on the value of the left most BCD digit.

If the left most digit is a 0, the International Telephone Code is used to indicate the country that the changer is set-up for. For example, the USA code is 00 01H (Z3 = 00 and Z4 = 01).

If the left most digit is a 1, the latest version of the ISO 4217 numeric currency code is used (see Appendix A1). For example, the code for the US dollar is 18 40H (Z3 = 18 and Z4 = 40) and for the Euro is 19 78 (Z3 = 19 and Z4 = 78). Use FFFFh if the country code is unknown.

For level 3 cashless readers, it is mandatory to use the ISO 4217 numeric currency code (see Appendix A1).

Z5 : Scale Factor.

The multiplier used to scale all monetary values transferred between the VMC and the reader.

- Z6 :** Decimal Places.
The number of decimal places used to communicate monetary values between the VMC and the payment media reader.

All pricing information sent between the VMC and the payment media reader is scaled using the scale factor and decimal places. This corresponds to:

$$\text{ActualPrice} = P \cdot X \cdot 10^{-Y}$$

where P is the scaled value send in the price bytes, and X is the scale factor, and Y is the number of decimal places. For example if there are 2 decimal places and the scale factor is 5, then a scaled price of 7 will mean an actual of 0.35.

- Z7 :** Application Maximum Response Time - seconds.
The maximum length of time a reader will require to provide a response to any command from the VMC. The value reported here supercedes the payment reader's default NON-RESPONSE time defined in section 7.5 if the value reported here is greater.
- Z8 :** Miscellaneous Options - xxxxyyyy
- xxxx: Unused (must be set to 0)
 - yyyy: Option bits
 - b0=0: The payment media reader is NOT capable of restoring funds to the user's payment media or account. Do not request refunds.
 - b0=1: The payment media reader is capable of restoring funds to the user's payment media or account. Refunds may be requested.
 - b1=0: The payment media reader is NOT multivend capable. Terminate session after each vend.
 - b1=1: The payment media reader is multivend capable. Multiple items may be purchased within a single session.
 - b2=0: The payment media reader does NOT have a display.
 - b2=1: The payment media reader does have its own display.
 - b3=0: The payment media reader does NOT support the VEND/CASH SALE subcommand.
 - b3=1: The payment media reader does support the VEND/CASH SALE subcommand.
 - b4-b7=0 Any future options must be covered by the EXPANSION COMMAND option bits.

Note: The following changes are the only changes to upgrade to battery operated readers:

If a VMC is battery operated, it signals the card reader with the flag 80H to work in battery operation mode. Within byte Z2 the reader also sets the flag to 80H to signal standby feature capability.

If only one of both is in standby capability, this results in an configuration error and the manufacturers should deal with handling of this condition. Assume that at least one device will not enter standby mode and therefore battery lifetime is dramatically reduced!

A2.4 VMC-Reader Operation Sequences

The VMC and the Reader should operate during battery mode in the following way:

After wake-up, the VMC starts with the normal sequences:

- Reset
- Setup/Config
- MAX/MIN-price
- Identify
- Enable
- Poll

During these sequences, the VMC has two possibilities to signal the Card-Reader, not to enter standby-mode again:

- Pulling the wake-up pin to low level
- Running poll sequences in continuous timing.

If neither the wake-up pin is driven low, nor any command is further sent to the card reader, the reader enters standby state after its Application Maximum Response Time (normally defined to 5 sec in ICP, but sent in byte Z7 of status response)

During card operation, the sequences continue normally with

- Begin Session
- Vend Request
- Vend Accepted
- Vend Success
- Cancel Session/Session Complete

Whenever a cancel session or session complete command is received, the reader should stop all internal work after a defined timeout period (Application Maximum Response Time) is finished after the last command sequence and after the wake-up pin is not pulled low.

The VMC should stop polling after the cancel session or session complete command and additionally should no longer pull wake-up pin.

If even the reader or the VMC may wish any further communication (i.e. for additionally trailing display messages or multi vend purposes or etc.) the reader can use any non idle answer to the poll command (i.e. the display message) whereas the VMC can continue polling or pulling the wake-up pin.

Note that the wake-up pin may not be used from the reader to hold on operation, cause dynamic system consideration and of course holding more devices within the system in normal operation mode is not a good job.

The reader should be in a power saving mode after this timeout period where power consumption is less than 10 μ A.

To allow the reader holding VMC operating, at least 5 poll have to be sent, after the cancel session or session complete. If any one of these polls is answered different with only a ACK, 5 polls have to be sent again. Note, that if a display message is sent, display time is added!

If the reader entered standby state, and a new card is inserted, the procedure starts a again.

Whenever during this next session, the reader should avoid all unnecessary work, i.e. display messages like „reader xyz, Software version 99.4711“ or „checking RAM“ and so on should be avoided. While in battery operation, the user has inserted a card and is waiting for display of his fund, to continue with a vend and is not interested in service related messages.

A2.5 Session Example

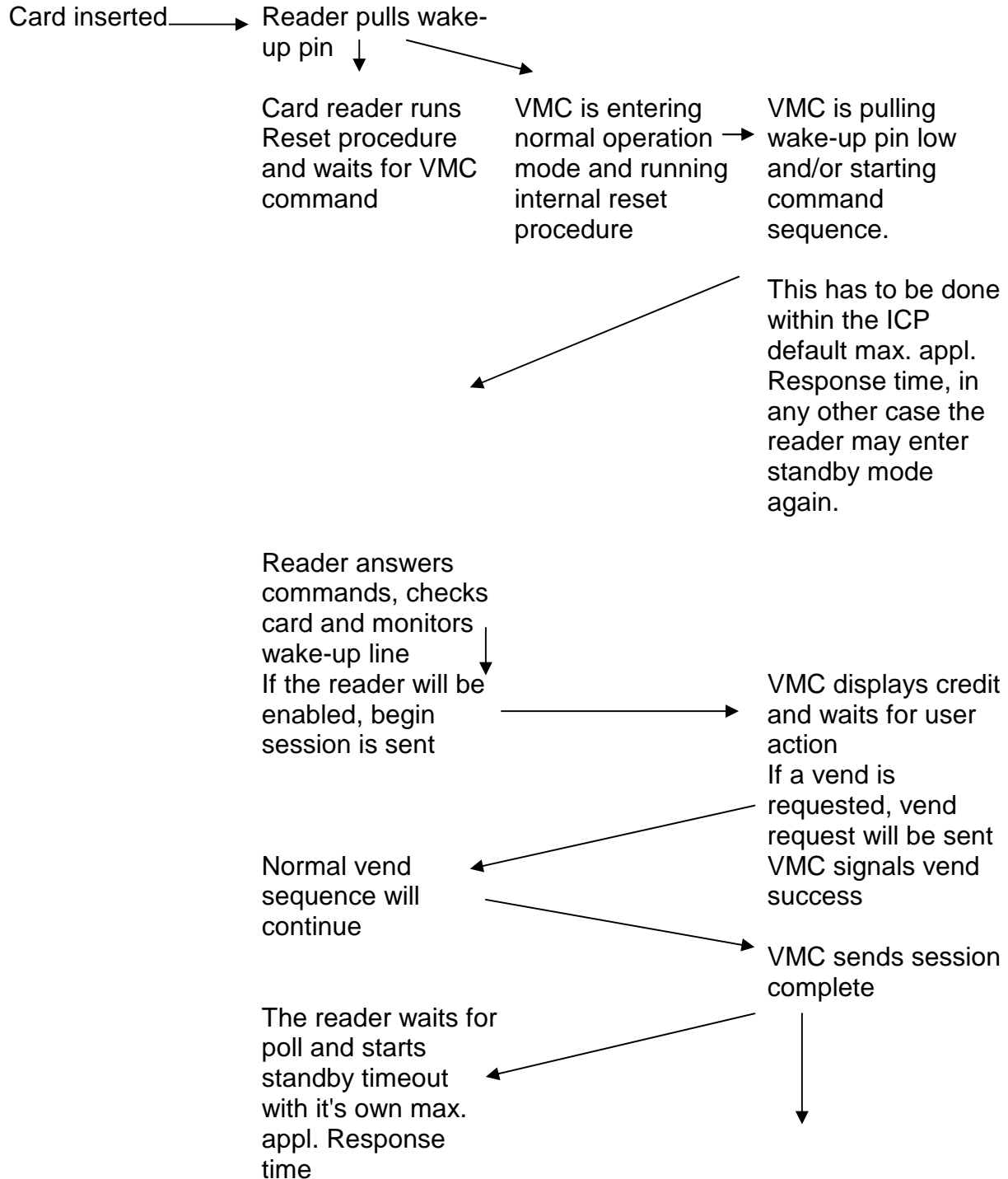

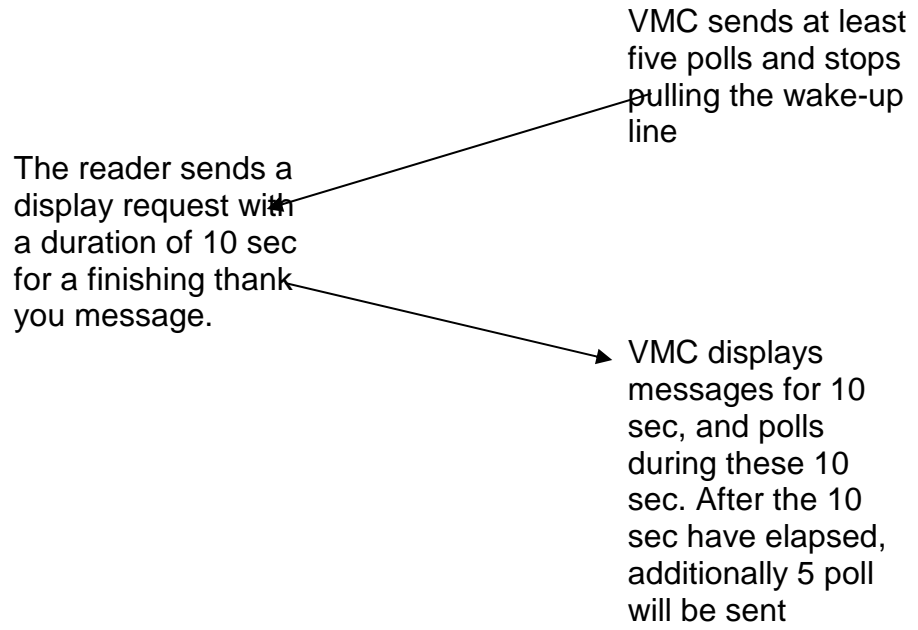

A2.6 Hardware Considerations

Hardware Considerations

Within this special battery operation, the pin 3 of MDB/ICP connector is used as a wake-up signal. Refer to special BDTA-hardware specification.

To show an example of the timing for this pin, refer to the following diagram, which gives an example of all special timing problems related to more than one wake-up condition.

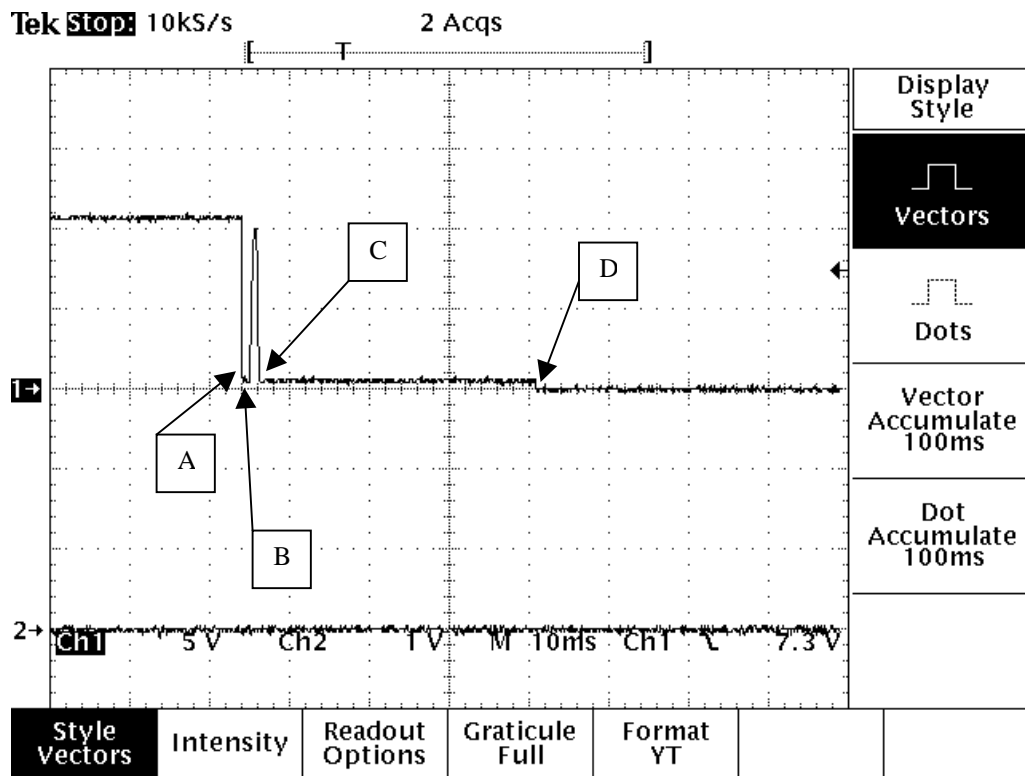

Position A: mechanical switch on VMC is pulling pin 3 low (i.e. door switch)

Position B: mechanical switch is released

Position C: card reader has finished reset routines and pulls pin 3 low

Position D: VMC has finished reset routines and pulls pin 3 low too.

If a card is inserted first, pin 3 may be pulled low first at position B.

If VMC is waked up via other means, maybe card reader is waked up at position D first.

In any case, this is a good example to clarify different waveform conditions on pin 3. Please note that any device may release pin 3 after a short duration (<1ms) cause pin 3 should work as dynamically wake-up. Holding pin 3 permanently low may prevent other devices from wake-up, i.e. after all devices ran into timeout and one is still holding pin 3, the other can no longer enter ready state (Note i.e. to door-switches etc.)

(this page intentionally left blank)

Appendix 3

MDB Recommended “Best Practices”

The following sections make recommendations that are intended to help reduce compatibility issues. Note that when developing a device you should not assume other devices or VMCs will follow these recommendations. Your device or VMC must meet the full MDB specifications!

- 1. Physical Connections (Power/Voltage/Connection)**
- 2. Timing Considerations (Lowest Level/Time-out)**
- 3. Commands, Repetition, ACK, NAK**
- 4. Logical Level, Processing**

1. Physical Connections (Power/Voltage/Connection)

Voltage specification (General)

Verify that the VMC meets the min MDB voltage at max load with the min input line voltage.

2. Timing Considerations (Lowest Level/Time-out) Timing Considerations (General)

To avoid timing issue (Section 3.1 Timing Definitions) it is recommended that you allow for some margin in your design. See table below:

Item	MDB Specification	Tolerated values
Communication startup	200ms	500ms
Communication response time (when waiting for a response)	5ms max	20ms*
Communication response time (when sending a response)	5ms max	4ms
Interbyte time (when receiving data)	1ms max	5ms*
Interbyte time (when sending data)	1ms max	0.8ms
Non-Response time (the time the device may be busy performing other processes. I.e., validating coins)	Varies per device	Plus the time between polls
Application Non-Response time (time that can be reprogrammed to be different from the default Non-Response time.	Varies per device	Plus the time between polls

*Using the tolerated values will provide compatibility with older equipment manufactured under the EVMMA version of the MDB specification that had the Communication response time at 20ms and Interbyte time at 5ms. The transmitting device must always use the values of the MDB specification.

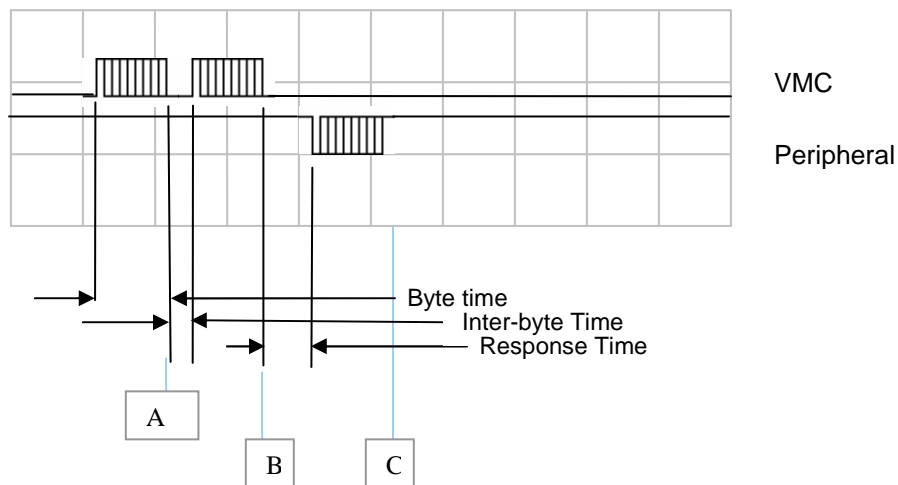

Please note, that the receiving device at the bus (master or slave) will get a receive interrupt (using standard UART devices) only after the byte is fully transmitted. These are the positions A, B, and C in the above diagram.

Therefore, the receiving device needs to set a higher value for the interbyte timeout, because it needs to add at least the transmission time for one byte (which is 1 start bit + 9 data bits + 1 stop bit at a rate of 9600 baud equal 1.2 ms). The same happens

for the response timeout, because the response is first detected, while the first byte is fully received.

Another common implementation error is checking the response timeout after the whole response message is received. This will never work because if, for example, the response is more than 5 bytes, the transmission time for 5 bytes will be more than 5 ms and will always timeout.

POLL Frequency (General)

Section 2.4.3 states, "Each peripheral should be polled every 25-200 milliseconds." However, the VMC is likely to stop communication during a vend or at other times when it does not need to communicate with the peripherals. Note that this may cause the peripheral(s) to RESET, see "Non-communication Time-out"-section in this document.

Because of this, poll frequency is not as important as many people think it is.

While not specifically prohibited, polling at a high rate while waiting for a response will usually delay the response, as the peripheral will have to service the POLL. Polling at a very low frequency, however may decrease coin or bill acceptance rate.

For all devices, the recommended VMC POLL frequency is 125ms - 200ms.

Example for a cashless device card acceptance:

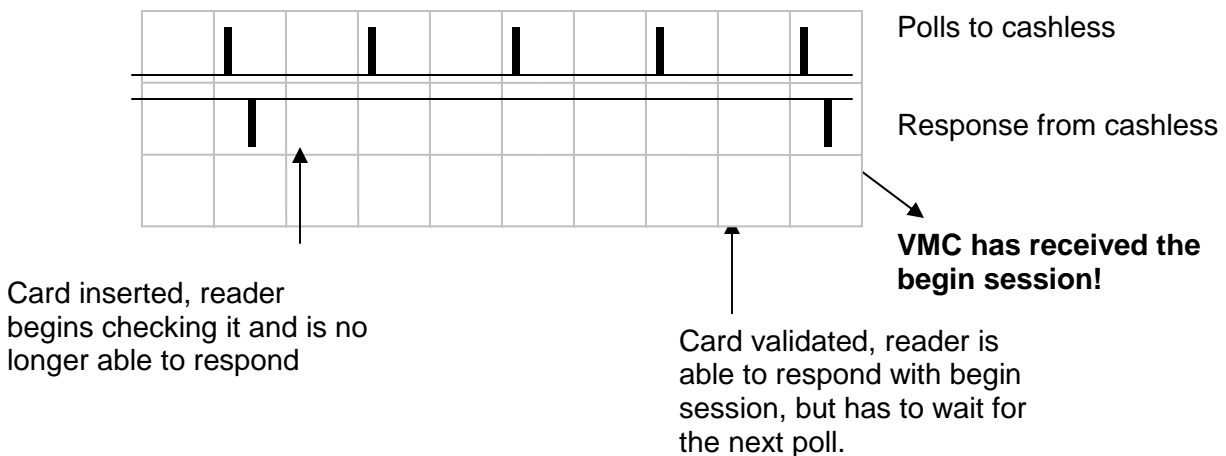

As shown in the above diagram, the time from card insertion to credit being displayed on the vending machine is not specifically related to the polling rate. After the card is inserted, the card reader validates the card. During this time, some card readers are no longer able to answer the poll, others answer with an ACK only.

When card validation is finished, the reader is ready to send the begin session, which will result in the balance of the card being displayed on the VMC. Obviously, this and only this depends on polling frequency. The time to the next poll has to be added to the validation time to get the maximum time before the credit is displayed.

Please note that some readers may need significant processing time to answer the polls. If a developer increases the polling frequency, this would extend the validation time instead of getting a faster reaction with begin session.

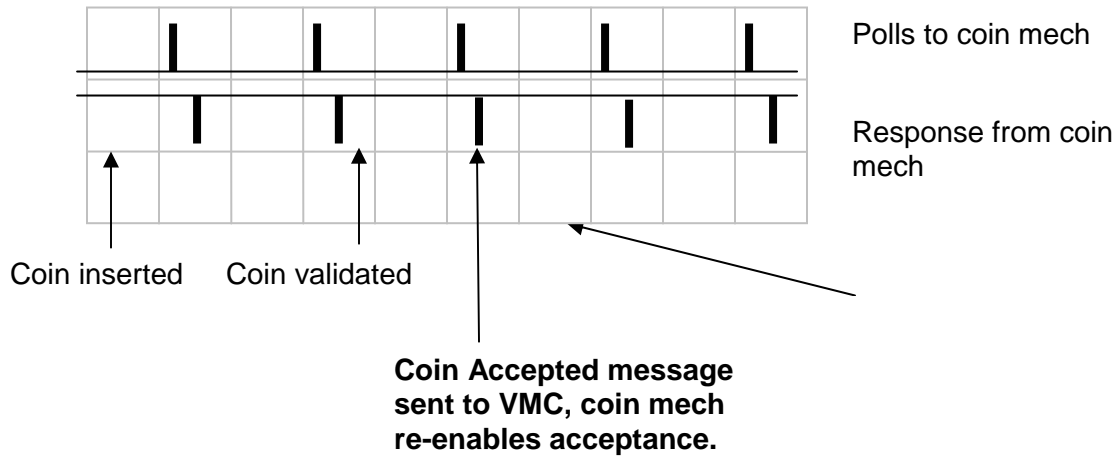
Example for a coin acceptor:

Note that some coin acceptors can send more than one coin message in response to a poll. The VMC must be able to parse multiple coin messages from one poll response.

General Data Response Timeout

Unless otherwise specified, a VMC should wait at least 30 seconds for a response to commands that require data to be returned. This does not infer that the device is not ACKing POLL commands, but rather the VMC is waiting for data pertaining to the command. I.e., for a PAYOUT VALUE command, the coin mech should respond to each PAYOUT VALUE POLL within 30 seconds.

Non-communication Timeout (General)

If a peripheral does not communicate with the VMC for an extended period of time, that peripheral should take care of any relevant house-keeping and then RESET. This time should be of sufficient length to guarantee that communications with the VMC have been completely lost. The recommendation is to wait at least 10 times the max response time for a device.

If the VMC does not successfully communicate with a peripheral for the 'application maximum response time', it should attempt to RESET that peripheral once every 10 seconds (Section 2.4.3 POLLing) and continue operations (if possible) with the other MDB peripheral(s) that are still responsive.

Poll Responses covered by note 1 -Sent once each occurrence (Coin Mech)

Some devices send this response each time the changer detects the condition. For example, the changer sees the gate open so it sends the escrow request, if the next time it checks it see the gate open it will send the escrow request again. Other devices will only send it once until the gate returns to the normal position.

It is recommended to send it only once.

3. 3. Commands, Repetition, ACK, NAK

NAK and RET (Section 2.2 Block Format)

The purpose of a NAK is ONLY to indicate a message has been received with a bad checksum. NAK is never intended to be used for a command that is understood, but not executable.

Since the error may be caused by the corruption of the address byte (shown in the following example), it is not recommended to use the NAK, but rather to not response. The 5ms non-response timeout will be treated as if it were a NAK (Section 2.2 Block Format/Master-to-Peripheral, Peripheral-to-Master and Response Codes).

RET is a VMC-only response that is sent to a peripheral to force it to retransmit its previous (and presumably good) response. (Section 2.2 Block Format/Response Codes).

Example of NAK or 'no NAK' with an error in the address byte:

The following example shows how you can get in trouble with a simple RESET COMMAND sent to a cashless device. Whereas the cashless device itself receives the command without error, the bill validator in the system sees a voltage transient (corruption) of the address byte.

VMC sends	Cashless received	Billval received	Cashless response	Bill validator response	
POLL to cashless	POLL valid CRC	command to other address			
			Sends a JUST RESET	Sends nothing	
Sends ACK to previous received just reset	ACK	ACK			
			Nothing	Nothing	
RESET to cashless	RESET valid Checksum	Instead of command to its address, receives command to address 30H with Checksum 10H (because the destination 10H address byte was modified by transient voltage)			
			Sends ACK after 4ms	Sends NAK after 1 ms	*
			Sends ACK after 1ms	Sends NAK after 4 ms	**
			Sends ACK after 3ms	Sends nothing	***

As is shown, with only a single bit toggled (10h is modified to 30h). Three different reactions are possible:

* 1st Example (shown in Blue):

The VMC receives a NAK first, but 3ms later, an ACK would arrive. If the VMC immediately sends a different command after the NAK the further answer of the next device would collide with the ACK of the cashless and cause a second failure.

** 2nd Example (shown in Red):

The VMC receives the correct ACK first and continues immediately (if it is using a very fast polling rate). The NAK of the bill validator will collide in any case with the next message and cause further errors!

*** Last example (shown in Green):

The VMC receives the correct ACK first and continues immediately (if it is using a very fast polling rate). The bill validator will not cause any further errors, because it sends nothing. In this, and only this case, if the cashless device has a checksum

error too, both devices would not answer. The VMC would then repeat the command after 5 ms, because it would interpret the timeout as an NAK.

Recommendations from here:

Newer peripherals should never send a NAK, to avoid further handling errors.

Newer VMCs should never try to increase the polling rate if they receive a NAK from a peripherals, instead they should wait for the full timeout period to expire (and skip) further ACK's and NAK's from other peripherals. Please note that if you have four peripherals on the bus, the VMC may receive at least four ACK's and/or NAK's in or out of sequence!

To improve system reliability you should implement the bit counting method defined in the note of page 2-4 of the MDB specification.

Command Repetition (General)

VMC commands which are not ACKed should be repeated for the duration of the non-response time-out. If the command is not a POLL it is recommended that the command should alternate with a POLL. This does not mean that the VMC cannot communicate with other peripherals on the bus, but it should continue to communication with any non-responsive peripheral until it can reliably conclude that it is offline. At that point, it should start trying to RESET that peripheral once every 10 seconds. (Section 2.4.3 POLLing). When it receives a response to the RESET the VMC will need to re-initialize the peripheral.

Command Repetition (special commands)

VMC commands which are not ACKed should be repeated for the duration of the non-response time-out. Please note, that this is a general guideline, which in some circumstances may not be a "successful" implementation.

Condition 1 (coin mech dispense)

If a dispense command is not ACKed, this may be

- a) a misunderstanding by the peripheral
- b) a corrupted bus signal
- c) another peripheral corrupting the bus

If the command itself did not arrive at the coin mech, repetition is ok. If the command arrived at the coin mech, but the VMC did not see the ACK, repetition obviously leads into multiple coin dispense!!!

In this situation, it is recommended not to re-send the command multiple times, although the choice is ultimately down to the system designer, and to wait for a while before restarting communications. This will allow any noise on the bus to dissipate.

Condition 2 (bill validator or coin mech acceptance)

If a bill validator accepts a bill or a coin mech accepts a coin, this is reported during the next poll to the VMC. This message is then ACK'ed by the VMC.

If this ACK is not detected by the bill validator or coin mech, for whatever reason, the peripheral repeats the message (this means, the same coin or bill value is sent again).

If the bill or coin value message did not arrive at VMC, repetition is ok. However, if the command arrived at the VMC, but the bill validator or coin mech did not see the ACK, repetition obviously leads into increasing credit!!!

Recommendation to minimize this effect especially for bill validators with high denomination values:

Whenever a VMC receives a bill (or coin) message, it should send the ACK, process the bill (or coin), wait for the recommended maximum response timeout (20ms) and send an additional poll.

If the VMC receives the same bill (or coin) message again after 20ms, (instead of receiving an ACK only) this can be assumed to be a repetition due to non-received ACK. If nothing is reported or a different value is sent, the ACK was understood or a new bill (or coin) has arrived.

This solution assumes, that bill (or coin) insertion is much slower than 20ms (which obviously is true especially for bill vals)

Command Order (General)

In most cases the VMC can send any command at any time in any order. Note the Cashless device spec is the only peripheral that defines the sequence of commands.

Command Out-Of-Sequence (Cashless Payment Device)

If the VMC receives a Command Out-Of-Sequence from a cashless payment device, it is a clear indication that the state of the cashless payment device is no longer in synch with the VMC. The VMC should take care of any relevant house-keeping and then issue a RESET to the cashless payment device. This will put both parties in a known state of operation.

4. Logical Level, Processing

Maintaining MDB Level Compatibility (General)

In a system where the peripheral supports a higher level MDB protocol than the VMC, the peripheral should revert to the lower level MDB protocol to communicate with the VMC. (Section 1.3.1 Levels and Section 2.4.4 Levels)

In a system where the VMC supports a higher level MDB protocol than a peripheral, it is the responsibility of the VMC to revert to the lower level MDB protocol when communicating with the peripheral. (Section 1.3.1 Levels and Section 2.4.4 Levels)

Response data length (General)

Note that some responses for peripherals can be variable length (tube status, poll, etc.). For example, a peripheral can send multiple messages in response to a poll command. Note that the 9th mode bit should be set on the last byte of the data being received (see section 2.5 Typical Session Examples)

Scale Factors (General)

The VMC needs to be able to handle devices with different scaling factors. The VMC needs to determine the least common dominator and adjust the values from each device.

Decimal point (General)

The decimal point information is only used to set the position on a credit display (it doesn't adjust the values).

Country Codes (General)

Do not require devices to have the same country code. In July 2000 the spec changed to use the ISO4217 numeric currency codes. Devices before that date used the international telephone codes.

Just Reset (General)

If a device sends a just reset response, the VMC should re-initialize the device (request setup information, re-enable the device, etc.). Don't send a reset command.

Multiple Coin Reporting

The VMC must take into account that coin mechs can send the value of more than one coin in one poll response.

Multiple Bill Reporting

The VMC must take into account that bill validators can send the value of more than one bill in one poll response.

Power-Up Sequence (Cashless Payment Device)

The following sequence is recommended as the power-up process for cashless payment devices. Post-RESET ACKs are not explicitly listed and are implied.

Send RESET until ACKed.
POLL until JUST RESET response.
Send SETUP/CONFIG command.
POLL until READER CONFIG response.
Send MAX/MIN PRICE command.
Send EXPANSION ID REQUEST.
POLL until PERIPHERAL ID response.

Send READER ENABLE command when ready.

Cashless Payment Device Enable/Disable (Cashless Payment Device)

While it is specifically allowed for “grandfather” reasons, a VMC should never need to disable a cashless payment device during a session. However, if this does occur, the cashless payment system should complete the session-in-progress normally (Section 7.4.12 READER – Disable), and subsequently refuse to start any new sessions with the VMC until enabled.

Level 2 BEGIN SESSION Command (Cashless Payment Device)

The description of Byte Z8 of the Level 02/03 BEGIN SESSION message (Section 7.4.4 POLL) appears to match the EVA-DTS Standard v.5.0, App. A.1 Definitions. All NAMA MDB specification references in this document are based on Version 3.0 (Draft 1), dated March 26, 2003, always refer to the latest EVA-DTS version.

Cashless Payment Device Discounting (Cashless Payment Device)

The VMC should not make any financial decision(s) based on the BEGIN SESSION balance. Some cashless peripherals support various types of discounting. Consequently, the VMC should not terminate a session if the reported balance is less than the minimum price or refuse to issue a VEND REQUEST when the list price of a selected item exceeds the reported balance of funds.

Similarly, if a cashless payment device reports a starting balance of 0xFFFF in the BEGIN SESSION message, the VMC should proceed normally i.e., permit a product selection. A BEGIN SESSION balance of 0xFFFF means that the available fund balance is not currently known and/or should not be displayed. It is not meant to suggest that the balance is insufficient for operation. An appropriate message for the customer should be displayed instead of the balance – i.e. “Please make a selection”.

Revalue Limit Requests (Cashless Payment Device)

Similar to discounting, some cashless devices are capable of granting “bonus” credit to users (i.e., giving \$6.00 credit for a \$5.00 bill). There may also be cases where a cashless device pre-deducts sales tax resulting in a credit that is less than the amount in the REVALUE command. Finally, most cashless devices that store credit on the media have a maximum allowable credit.

Consequently, the VMC should issue a REVALUE LIMIT REQUEST prior to determining which fund sources (e.g. note values) are applicable to a user. In a multivend environment, this means the VMC must issue multiple REVALUE LIMIT REQUESTs.

If a cashless device cannot accept credit, either because the operation is not acceptable at this time or because the current media has reached its maximum credit limit, the device should respond to a REVALUE LIMIT REQUEST with a REVALUE DENIED not a REVALUE LIMIT of \$0.00. The REVALUE DENIED response clearly signals that revalue is not an acceptable operation.

Balance Display (Cashless Payment Device)

For VMCs that opt to show the available funds, it is important to consider the following:

Cashless payment devices with active discounts will deduct less than the VEND REQUEST amount. The displayed balance in the VMC must reflect the difference between starting balance and the amount in the VEND APPROVED message (not the VEND REQUEST). This assures that the displayed balance on the VMC is correct, and (where applicable) matches the cashless payment device's display.

Because the REVALUE APPROVED message does not contain an amount field like VEND APPROVED, the VMC is not capable of tracking card balance correctly in a "bonusing" environment.

Multi-Vend (Cashless Payment Device)

Multi-vending is the practice of vending multiple products within a single session. While multi-vending is a function of the VMC, it should only be attempted when the multivend bit (b1) of the Miscellaneous Options byte (Section 7.4.2 Setup- Config Data/ Byte Z8) of the cashless device's configuration data is set (b1=1).

If a VEND DENIED scenario occurs during a multi-vend session, the VMC has the option to terminate or continue the vend session. It may be that the user tried to buy something that cost more than his balance. If the VMC has less expensive goods to vend, continuing the session would give the user an opportunity to select something affordable.

If a VEND FAILURE scenario occurs during a multi-vend session, the VMC should always issue a VEND FAILURE to the cashless payment device. The VMC has the option to terminate or continue the vend session. It may be that the user selected an empty column, and another selection will be successfully vended.

Display Messages (Cashless Payment Device)

If Byte Y3 (Columns) and/or Y4 (Rows) of the SETUP/CONFIG message are zero, VMC display is not available for use by the cashless payment device (Section 7.4.2 SETUP – Config Data).

If the display is available, a Display Request message can be sent anytime after the power-up sequence has been completed. In practice, there are only a few conditions under which the cashless payment device should make a Display Request:

1. Immediately after the power-up sequence is completed to display the cashless payment system's software revision number. This should not create significant problems because it only happens at power-up.
2. Anytime the cashless device is out of service.
3. In the enabled state to indicate an error accessing the media (e.g. busy signal for a credit card reader). This should not create a conflict because a) it is transient, and b) the user should be concentrating on the purchase process.
4. In the enabled state to prompt the user (e.g. for a PIN). This should not create a conflict because a) it is transient, and b) the user should be concentrating on the purchase process.
5. In the enabled state to inform the user of the funds available for purchase. This should not create a conflict because a) it is transient, and b) the user should be concentrating on the purchase process.
6. During session idle (e.g. after a VEND DENIED to indicate the reason for the refusal). This should not create a conflict because a) it is transient, and b) the user should be concentrating on the purchase process.

If the VMC reports itself to support Full ASCII (Y5 = xxxx001b) then it will support all printable ASCII characters (0x20 thru 0x7F). If values outside this range are used, the results are dependent upon the actual display controller chip. This is strongly discouraged.

Selected Number (Item Number or Product Code?) (Cashless Payment Device)

The selected number should be the vending machines selection number, which is normally the product key index. If the VMC i.e. has a two digit input, where one is alphanumerical, ("A-1" or "C-6" or ..), it has to convert it in a appropriate way to a number. To be compatible to all versions of card-readers and DTS-versions, ensure the number is in the range of 1-n. The maximum of n depends on the level used and options (1-255 or 1-65535).

The conversion method and the maximum selection number should be published by the VMC vendor to ensure the correct settings of the cashless device. Vice-versa, the cashless device vendor should publish the maximum usable numbers of selection, and the default action, if a selection number out of this range is sent.

Normally, this default action should result in a simple conversion to the maximum number and accepting the price from the vending machine, skipping all internal discounts etc.

Combining a VMC and a cashless device which do not have compatible maximum selection numbers is not an issue MDB has to solve, but is an application setup error.

Bill Stacking/Escrowing (Cashless Payment Device)

As a general practice, the VMC should escrow any bills tendered for credit to a cashless payment device until it has verified that the cashless payment medium can accept the full credit amount. This is done via the REVALUE LIMIT REQUEST command/response sequence. Once the value has been deemed acceptable, the VMC should stack/secure the bill prior to issuing the REVALUE REQUEST to the cashless payment device. This provides maximum protection against theft attempts. (Section 7.4.16 Revalue)

Mixed Tender Transactions (Cashless Payment Device)

Historically, this practice has been avoided by the VMC disabling the other peripherals when one becomes active (i.e., if someone inserts a bill into the validator, the VMC will disable the cashless payment device). If mixed tender transactions are to be supported, we must determine which fund source has priority for purchases, as well as for dispensing change.

There are two issues here:

1. If revalue is permitted, always revalue first, and then any purchase(s) should be from the card.
2. If revalue is not allowed, use cash first, and then deduct remaining funds from card.

Example: A mixed-tender VMC accepts \$1.00 bill and a user inserts a \$5.00 card.

Revalue Permitted: The \$1.00 bill is stacked and a REVALUE REQUEST for \$1.00 is sent to the cashless payment device. Once approved, any purchases should come from the \$6.00 card balance.

Revalue Not Permitted: The \$1.00 remains in escrow. The user selects a \$1.50 item. The VMC sends a VEND REQUEST for \$0.50 to the cashless payment device. If and only if it gets a 'vend approved', it will use/stack the \$1.00 in escrow and sell the product. If it cannot stack it, the vend will be aborted and a vend failure will be sent. (Note: The cashless payment device will assume a \$0.50 product was sold even though the Item Number may have been sold previously for \$1.50.)

Obviously, this combination of settings causes more problems than the "non stacking" combination.

First: if the cashless gives a discount, the discount may reduce the price to a value less than the vend request (because the calculation uses the \$1.50 value). This would result in stacking less than the whole bill, which is not possible! In this case, a vend denied should be sent. This method would temporarily disable the mixed payment.

Second: if refund is not possible, aborting of a vend will result in a credit loss situation. The VMC should use the opposite vend procedure – i.e. first stack the bill and then send the vend request. But, if in this case a 'vend denied' is received, the VMC needs to give change for at least the bill value!

MDB does not specify handling procedures for all these combinations – the operator needs to check the VMC and/or cashless capabilities as this is not an issue with the standards but a "market feature" problem.

Fund handling with a VEND FAILURE (Cashless Payment Device)

Normally funds are the responsibility of the fund source, (i.e., the cashless payment device). If a VEND FAILURE occurs the funds in question can be handled as follows:

NOTE: To prevent double refunds where the cashless payment device provides a process for refunds, the cashless device must indicate that the media supports refunds, regardless of whether or not it can actually transfer the lost funds back to the payment media.

The correct handling for vend failure is always, that no credit should be converted i.e. cash credit is escrowed, card credit is refunded. Card credit will never be transformed to cash!!

If the cashless device is not capable of refunding, for whatever reason, the VMC, and maybe the cashless device, may produce a log file or a statistic to ensure this is recorded. However, the credit balance in this case is always lost and may only be refunded to the customer by manual intervention (hotline, etc.)

If the cashless device is capable of refunding, nothing else is necessary. Sometimes, if a special card is used or the card is no longer present, refunding is not possible. In this case the same procedure as described above must be followed.

If the system allows the card refund amount to be transformed to cash, the following should be taken into account:

- a. The VMC can make a record of the lost funds and remove them from escrow.
- b. The VMC can retain the credit and allow it to be used as part of a cash purchase.
- c. The VMC CANNOT dispense the funds as change. In the case of a credit card charge or where the original source of funds was a credit card transaction, this constitutes a cash advance, all be it small.
- d. Please note further, that the VMC may have problems dealing with a discount amount.
- e. Please note further, that the cashless payment scheme may not allow this behaviour.

Fund Handling with a Negative Vend Failure

After a vend is approved, it is up to the cashless device how it handles the negative vend value

State Machine (Cashless Payment Device)

The defined state machine within the standard is information for both VMC and cashless programmers of the logical steps required to run the device.

In any case, the state machine should never be used as medium to swap the Master-/Slave device functions. In MDB, the VMC is always the Master device. This results in a unspecified sequence of commands for the VMC (as for all other devices). i.e. even if the device has reached the begin session state, the VMC is allowed to send, for example, an FTL command. If the cashless is not able to support this command in the current state, it may send the applicable response (i.e. FTL denied), but will continue in the reached state!!

Further examples of this are multiple "Vend Session Complete" or similar commands. Because the cashless device enters the inactive state with the first vend session complete, further repeated commands will never produce any problems and may simply be ignored.

A lot of cashless devices use the “out of sequence” message in this case. This may be appropriate in terms of “educating the VMC programmer”, but will never solve the issue. The “out of sequence” message usually causes the VMC to send a reset command to re-sync the devices. This is not a problem for the VMC, but can cause the cashless device to run into problems - mainly because the reset sequence of a lot of cashless devices can take many seconds, during which the customer is unable to use their cards. This obviously can lead to complaints.

The “Out of sequence” message should be the last resort for a cashless device, to be used only if it is unable to solve state machine problems any other way. Unfortunately, due to the polling mechanism with a finite polling frequency, the loss of synchronisation between the VMC and the cashless state is unavoidable.

An example of this is as follows:

After a card insertion we get a begin session.

Both devices enter the session idle state.

The customer presses the escrow lever and takes the card out simultaneously.

The VMC would send a Reader Cancel command, whereas the cashless would like to transmit an end session (because its session ended when the card was taken out).

The situation then arises that the cashless device is in the inactive state (no card present), but cannot send the message to the VMC (no poll available, instead a wrong command for this state).

The VMC, on the other hand, believes it is sending the correct command, as it is still in the session idle state. Hence, it would repeat the cancel session, until it is answered. It would then get a totally unnecessary “out of sequence”, and maybe an additional "end session".